

TONON collection

TONON collection

l'azienda

the company

Passione, esperienza, ricerca:

dal 1926 sedute e complementi d'arredo per il mondo residenziale e Ho.re.ca.

Passion, experience, research:

since 1926 pieces of furniture with an international design for the residential and Ho.re.ca world.

Grazie alla stretta collaborazione con importanti designer di fama internazionale, il nostro stile è eclettico e cosmopolita. La nostra filosofia si concentra nella ricerca del corretto equilibrio tra materia e forma, estetica e funzione, producibilità e originalità. Il valore del "fare bene" lo coniughiamo nella costante ricerca delle migliori soluzioni per realizzare sedute e arredi di uso quotidiano che possano accompagnare nel tempo, procurando un momento di benessere in ogni momento trascorso a casa, come in ufficio, in albergo, al ristorante.

Thanks to the support of leading international designers, our style is eclectic and cosmopolitan. Our philosophy focuses on pursuing the correct balance between matter and form, aesthetics and function, producibility and originality. We combine the value of "doing well" with the constant search for the best solutions, in order to create chairs and furnishings for everyday use which can last over time, making the living of every environment, at home as in hotel, in restaurant as in office, a moment of well-being.

the history



manzano 1926
the location of the company is in the northeast of italy, the friuli area in the village of manzano



"la fabbrica" 1950
tonon is growing up to 220 workers. in the area the people are calling the company tonon simply "la fabbrica" (the factory)



the thirties 1933
tonon delivers deckchairs for the cruise ship rex for lloyd trieste



the sons 1960
augusto and bruno tonon lead the company in the 60ies, supplying the italian furniture industries as subcontractor



high gloss lacquer 1981
high gloss furniture are coming in fashion. tonon gets with the paperclip chair a bestseller in america. department stores as bloomingdale and macy's sell the chair all over the united states



the research 1985
in cooperation with the designer paolo nava and a company in the aircraft industry tonon is developing the first carbonfiber chair

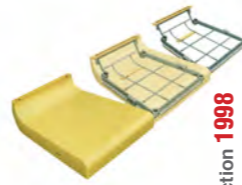

the change of upholstery 1998
tonon is changing from the traditional upholstery on wooden frame to shells with steel construction and injected foam



new materials 2003
the first chair in skin injected foam is born (integral foam)



You for me 2007
sandro tonon develops together with 6 designers a fully upholstered collection all manufactured with injected foam shells



up - chair 2011
the up-chair immediately gets the favorite in all international markets, both for the material and for its organic design

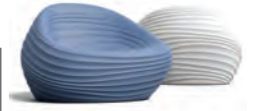

river side 2016
the product manufactured in soft touch polyplus for indoor and outdoor seating



fb @ 2018

1926

the founder
alberto tonon "cavaliere del regno" founds the company



technology of bent wood 1929
alberto tonon, brings as first the technology of bent wood to italy



bicycle wheels 1935
the economic crisis in italy, everything is lacking, tonon specializes in the production of bicycle wheels in wood



sandro tonon 1971
sandro tonon joins the company. bringing tonon back to its own brand. uniforma, is the first collection of design after supplying the furniture industry



jonathan chair 1983
paolo nava creates the jonathan chair. a new interpretation of the typical bent chair of the past.

contract collection 1986
tonon opens a new market in the horeca business (hotel, restaurant, cafeteria). the wide program of the flower collection gives an answer for every destination. hotel chains like sheraton, holiday inn, hilton etc. get customers of tonon.



not only wood 2000
follow me is the first collection of tonon that includes metal chairs



international awards 2002
reddot design award
shell is one of the first winning products of tonon in a design award



here comes the sun 2009
the first outdoor collection. tonon invests in moulds. sundance, sunrise and sunset are produced in polyethylene with a rotational moulding process.



sideboard move 2015
our first sideboard is born with carpet front doors in wood or in soft touch



corda collection in & out 2019

In the difficult period of the pandemic, which unfortunately stopped the activities all over the world, Tonon continued the research and development of new collections, with great attention to the moments of change we were experiencing. This is how the Moon was born, created by the professionalism and creativity of Mac Stopa, a collection that in a short time became the "best seller" of our company.















TONON today

DINING

 moon pag. 6	 little moon pag. 16	 full moon pag. 24	 quo pag. 28	 pretty pag. 34	 fl@t pag. 36	 up pag. 44	 concept pag. 58	 step pag. 64	 lucky pag. 72	 sailor indoor pag. 76
 triangolo pag. 82	 miss pag. 86	 pit&pit 2 pag. 88	 wave pag. 92	 flower pag. 98	 salt&pepper pag. 100	 basic 2 pag. 104	 shells pag. 106	 club pag. 108	 fusion pag. 110	 wine pag. 112
 tendence pag. 114	 fancy pag. 116	 swing pag. 120	 for us pag. 122	 gamma pag. 126	 lili pag. 128	 spring pag. 130	 sella pag. 132	 brand pag. 134		

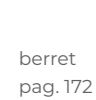
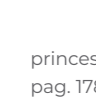
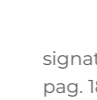
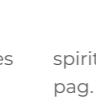
TIMELESS DINING

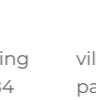
 libra pag. 136	 chic pag. 146	 timeless pag. 148	 jonathan pag. 152	 wind pag. 154	 piccola ketty pag. 156	 lord gerrit 2 pag. 158	 euthalia pag. 164	 friendly pag. 166	 ensemble pag. 168	 gallant pag. 170
 berret pag. 172	 princess pag. 178	 signatures pag. 180	 spirit pag. 182	 charming pag. 184	 villa pag. 186					





















LOUNGES

 loft pag. 222	 up pag. 228	 step pag. 70	 fl@t pag. 41	 wave pag. 96	 question mark pag. 232	 first class pag. 238	 globe pag. 240	 matchball pag. 236		
 pyramid pag. 242	 lady pag. 244	 fly too pag. 246	 antheia pag. 248	 libra pag. 140	 lord gerrit 2 pag. 161					



OUTDOOR

 sailor collection pag. 188	 corda collection pag. 198	 river collection pag. 210
---	--	--







STOOLS

 up pag. 49	 quo pag. 31	 concept pag. 61	 step pag. 71	 lucky pag. 72	 little moon pag. 22	 fl@t pag. 42	 pretty pag. 35	 wave pag. 95	 question mark sella pag. 233	 sella pag. 132
 libra pag. 139	 lord gerrit pag. 161	 friendly pag. 166	 tendence pag. 114	 signatures pag. 181	 villa pag. 186	 euthalia pag. 164	 beret pag. 175	 gallant pag. 171	 princess pag. 178	

TABLES

 4 meters pag. 250	 steel pag. 254	 u table pag. 260	 salt & pepper pag. 262	 salt & pepper2&eco pag. 266	 tabula pag. 270
 tube pag. 272	 arcos pag. 274	 mac's table pag. 276	 839 pag. 280	 time pag. 282	 sella pag. 284

COFFEE TABLES

 libra pag. 286	 grace pag. 288	 up table pag. 290	 diamonds pag. 292	 frame pag. 294	 libra pag. 296
--	--	---	---	--	--

FURNISHING

 time pag. 298	 sailor pag. 196	 corda pag. 208	 parentesi pag. 300	 lampada pag. 302
---	---	--	--	--

MOON 908

design **mac stopa**

SOFT TOUCH & UPHOLSTERED

Superfici piene e spazi vuoti, in perfetto equilibrio tra di loro.

Solid surfaces and empty spaces, in perfect balance with each other.

Per chi si è perso a guardare l'indicibile bellezza della luna, in ogni sua fase. Per chi ha alzato lo sguardo, di notte, con occhi sognanti, viaggiando con la mente verso quel mondo lontano. La luna, irraggiungibile e allo stesso tempo magnetica, è da sempre oggetto di poesie, storie, desideri. Così il designer Mac Stopa ha voluto renderle omaggio, esprimendo attraverso il design le forme piacevoli e sognanti della luna.

For those who have lost themselves in watching the unspeakable beauty of the moon, in every phase. For those who have looked up, at night, with dreamy eyes, traveling with the mind towards that distant world. The moon, unreachable and at the same time magnetic, has always been the subject of poems, stories, desires. So the designer Mac Stopa wanted to pay homage, expressing through design the pleasant and dreamy shapes of the moon.



H 908.B1

MOON SOFT TOUCH

Design organico.
Organic design.

La forma scultorea della Moon di Mac Stopa per Tonon esprime la passione del designer per le linee curve e organiche. Lo schienale si fonde armoniosamente e diventa tutt'uno con i braccioli e con il sedile, creando uno spazio aperto tra schienale e sedile, a forma di mezzaluna: questo è ciò che la rende affascinante e unica.

The sculptural shape of the Moon chair by Mac Stopa for Tonon expresses the designer's passion for curved and organic lines. The backrest bends harmoniously and becomes one single piece with the rest of the shell, creating an open space between the backrest and the seat, in the shape of a half moon: this is what makes it fascinating and unique.



MOON SOFT TOUCH



908.11



908.L1



908.B1



908.A3/A5



908.01



908.03/05



908.73/74



908.81



908.91



H 908.11
TT 216-213

MOON UPHOLSTERED



908.31



908.L2



908.B2



908.E3/E5



908.21



908.D3/D5



908.75/76



908.82



908.92

MOON UPHOLSTERED

Design ergonomico.
Ergonomic design.

La struttura della Moon, studiata con precisione, si adatta perfettamente alla posizione del corpo: sedersi diventa un piacere. La scocca dalla forma organica è realizzata anche in poliuretano schiumato rivestito in tessuto o pelle. La scocca adatta le sue linee alla forma del corpo e dona una piacevole sensazione di morbidezza per il massimo comfort.

The structure of Moon, studied with precision, adapts perfectly to the position of the body: sitting becomes a pleasure. The organically shaped shell is also made in flexible injected foam upholstered with fabric or leather. The shell geometry adapts its lines to the shape of the body and gives a pleasant sensation of softness for a maximum comfort.





H 908.21
TT 827

LITTLE MOON 908

design **mac stopa**

SOFT TOUCH & UPHOLSTERED

Little Moon, come suggerisce il nome, è un modello dalle dimensioni più contenute rispetto a Moon, leggermente più stretto ma con lo stesso obiettivo di offrire il massimo del comfort. La scocca del sedile è realizzata sia in integrale "soft touch" sia in poliuretano schiumato e rivestita in tessuto o pelle. La scocca resistente e indeformabile è flessibile e morbida e, grazie all'ampia scelta di basi disponibili, nulla è lasciato a desiderare. Lo schienale con apertura a mezzaluna si lega con successo alle linee della sorella maggiore Moon, che ha ricevuto numerosi premi di design.

Little Moon, as the name suggests, is a model with smaller dimensions than Moon, slightly narrower but with the same goal to offer the maximum comfort. The shell is made both in "soft touch" integral foam or in injected foam upholstered with fabric or leather. The non-deformable and resistant shell is flexible and soft, and thanks to the large selection of bases available, nothing is left to be desired. The backrest with its crescent-shaped opening, matches successfully with the lines of its big sister Moon, which has received several design awards.



h 908.83

Little moon imbottita.
Little moon upholstered.



h 908.84
h 827



Little moon soft touch.
Little moon soft touch.

TONON

H 908.12
TT 839



TT 908.41



h 908.54

FULL MOON 908

design **mac stopa**

La seduta top di gamma della collezione Moon.
The top range of the Moon collection.

Full Moon è l'ultimo modello della collezione MOON; caratteristico questa volta è lo schienale chiuso, che si sviluppa armoniosamente formando i braccioli e terminando nella seduta che offre ampio spazio per il relax. La Full Moon è leggermente più grande e più morbida ed è progettata principalmente per il comfort. La scocca è costituita da poliuretano espanso schiumato a freddo e da un cuscino di seduta integrato con morbida imbottitura. Il rivestimento in tessuto o pelle è impreziosito dalle precise cuciture, dettaglio che, insieme alla nuova struttura della base in metallo appositamente studiata per questo modello, fa di Full Moon un prodotto top di gamma che si inserisce in ogni ambiente.

Full Moon is the latest model in the MOON collection, with its characteristic full backrest, which fits harmoniously into the armrests and the seat offering space for relaxation. Full moon is slightly wider and softer and is mainly designed for comfort. The shell is made of injected foam, padded with soft foam in the seat. The fabric or leather upholstery is embellished by the accurate stitching, a detail that, together with the new metal structure specially designed for this model, makes Full Moon a top-of-the-line product that looks good in any location.



H 908.60
TT 248



H 908.60
TT 248

QUO 910

design **martin ballendat**

SOFT TOUCH & UPHOLSTERED

La sua forma ricorda quella di una clessidra, grazie alla torsione che troviamo nello schienale. Il risultato è piacevole alla vista ed anche estremamente funzionale: infatti lo schienale, con la sua leggera flessibilità, si adatta alla schiena e la accoglie donando grande comfort. Un design capace di arredare gli ambienti residenziali e le aree commerciali, caratterizzando con la sua forma peculiare qualsiasi spazio.

The Quo chair's shape resembles that of an hourglass, thanks to the twist we find in the backrest. The result is pleasing to the eye and extremely functional. The backrest, with its slight flexibility, adapts to the back and offers great comfort to those who sit in the chair. A design capable of furnishing residential and commercial areas: characterizing any space with its peculiar shape.



H 910.21
TT 277





H 910.93
TT 843

PRETTY 94W

design christian werner

Un piccolo sogno.
A little dream.

Con un linguaggio formale teso alla semplicità, Christian Werner ha disegnato "Pretty", una poltroncina con lo schienale curvo, che trasmette una sensazione di intimità: capace di inserirsi nella sala da pranzo o nella sala di un ristorante, dove sedersi e potere condividere una cena in compagnia.

'A formal yet simplistic armchair, 'Pretty' has been designed by Christian Werner with a curved backrest. The design is suitable for dining rooms, restaurants and coffee bars where you can share dinner with friends.



H 94W.10



H 94W.42

FL@T 923/ 9W3/ 9X3

design martin ballendat

UPHOLSTERED, SOFT UPHOLSTERED AND SOFT UPHOLSTERED WITH ZIP

Fl@t nasce da una sottile sagoma "piana" e flessibile. cambiando così i canoni della tappezzeria. Questa viene ritagliata, rivestita e successivamente piegata e fissata sulla struttura della poltroncina. Uno dei risultati più interessanti sono proprio le pieghe all' interno dello schienale nella versione "soft" che rendono il prodotto esteticamente d'impatto.

The Fl@t collection starts as a thin, flat, and flexible shape. The shape is cut out, upholstered, and later folded and fixed onto the structure of the armchair. One of the most interesting results is the folds on the inner backrest of the 'soft' version, which gives the product an impactful aesthetic.



923.B1 FL@T ARMCHAIR
UPHOLSTERED

9W3.B1 FL@T ARMCHAIR
SOFT UPHOLSTERED

9W3.B2 FL@T CHAIR
SOFT UPHOLSTERED



FL@T ARMCHAIR
SOFT UPHOLSTERED WITH ZIP

H 9X3,81
TT 827



H 923.81
TT 839



H 9W3.12
TT 827



923.74



9W3.11



9W3.65



9W3.B2



9W3.02



923.65



9W3.01



923.41



923.52



FL@T LOUNGE UPHOLSTERED

h 924.81



h 923,52



h 923,41

UP SOFT TOUCH 907

design **martin ballendat**

Design organico.
Organic design.

La sedia "Up soft touch" ha forme sinuose e leggere, grazie all'ampio respiro dei braccioli: ciò la rende estremamente versatile per la casa nella zona living, nel ristorante, nella camera di casa come in quella d'albergo, accostata al piano scrittoio.

The "Up" chair has sinuous and light shapes, thanks to the comprehensive armrests: this makes it extremely versatile for residential settings, whether it's the living area, bedroom or home office, or hospitality environments, such as a restaurant or hotel room.



H 907.B1



H 907.11



h 907.11
■ 903.00
TT 843



907.11



907.03/05



907.13/15



907.01



907.73/74



907.A3/A5



907.B1



907.61



907.L1



907.51



907.41

907.45

Up-sgabello.
Up-stool.

Nell'open space di un'abitazione, per una colazione veloce alla mattina oppure per un aperitivo pre-cena a fine giornata, stando assieme in piacevole compagnia.
In the open space of the house, for a quick breakfast in the morning or for a pre-dinner aperitif at the end of the day, gathering together in pleasant company.

UP UPHOLSTERED 907

design martin ballendat

Qualità.
Quality.

La "Up chair" è un prodotto di qualità, dallo stile contemporaneo e dalle forme rotonde e organiche. Le sue linee sono studiate per offrire comfort e sostegno per la schiena.
"Up chair" is a quality product, with a contemporary style and round, organic shapes. Its lines are designed to offer comfort and back support.



H 907.L3
TT 843



907.82



907.93/94



907.21



907.23/25



907.31



907.D3/D5



907.L3



907.66



907.B2



UP WOOD 917

design **martin ballendat**

SOFT TOUCH & UPHOLSTERED

Up-chair, il bestseller nato nel 2012.

Up-chair, the bestseller created in 2012.

Alla scocca in materiale tecnico soft touch o in schiumato a freddo imbottito viene abbinato un bracciolo in legno massello di noce canaletto oppure rovere. Dei materiali innovativi ed un dettaglio in legno dalla lavorazione artigianale hanno creato un vero capolavoro.

The shell in the technical soft touch material or in injected foam upholstered is enriched with wood armrests in solid American walnut or oak. Innovative materials and the craftsmanship in the wood manufacturing have created an authentic masterpiece.



h 917.11



h 917.15

UP WOOD DINING



h 917.28

UP WOOD LOUNGE

CONCEPT 902

design martin ballendat

SOFT TOUCH

La prima seduta in poliuretano integrale.
The first seat in integral polyurethane.

“Concept” è una sedia con una storia ventennale: sviluppata nel 2002, è stato il primo prodotto a presentare la scocca in poliuretano integrale “soft touch”, materiale morbido, innovativo e dalle sorprendenti qualità.
“Concept” is a chair with a twenty-year history: developed in 2002, it was the first product with the shell made of integral “soft touch” polyurethane, a soft, innovative material with surprising qualities.



902.01

902.11



CONCEPT 2 902

design martin ballendat

SOFT TOUCH & UPHOLSTERED

Design iconico.
Iconic design.

Disegnata dal designer Martin Ballendat, apprezzato a livello internazionale, la seduta Concept si caratterizza da linee invitanti e riconoscibili. Lo schienale avvolgente si prolunga verso l'esterno, smussandosi, offrendo così un comodo appoggio alle braccia. Designed by the internationally acclaimed designer Martin Ballendat, Concept is characterized by inviting and recognizable lines. The enveloping backrest extends outwards, becoming rounded and offering a comfortable support for the arms.



902.E2



902.C2

SOFT TOUCH



902.07



902.10



902.81



902.52

UPHOLSTERED



902.27



902.30



902.82



902.54



H 902.30
TT 216-213

STEP 904/ 9W4

design **mac stopa**

FAMILY OF CHAIRS, ARMCHAIRS, LOUNGE AND BARSTOOL IN SOFT TOUCH, UPHOLSTERED AND SOFT UPHOLSTERED

Un programma completo di sedute, proposte in materiali diversi, per essere talvolta protagoniste, talvolta solo con una presenza neutra, comunque sempre indiscutibilmente proprio comode.

A full program of seats, offered in different materials to be sometimes the protagonist and sometimes just a neutral presence, in any case always unquestionably comfortable.



904.83
UPHOLSTERED



9W4.67/68
SOFT UPHOLSTERED



904.01
SOFT TOUCH



904.11
SOFT TOUCH



9W4.93
SOFT UPHOLSTERED



904.21
UPHOLSTERED



9W4.L3
SOFT UPHOLSTERED



904.S1
SOFT TOUCH



904.B3
UPHOLSTERED



h 9W4.93
h 9W4.94
F509
TT848

Look a scelta.
Look of your choice.

L'impiego di tessuti diversi per il rivestimento di questa collezione, dalle trame più classiche, eleganti e formali, a quelle moderne, con toni più accesi, crea un look unico e particolare.

The use of different upholstery options for this collection creates an unique and special look, from the most classical textures, elegant and formal, to the modern ones with brighter color tones.



h 904.93
h 904.94
F509
TT848



904.65
SOFT TOUCH



904.32
UPHOLSTERED



9W4.60
SOFT UPHOLSTERED



9W4.22
SOFT UPHOLSTERED



904.77/78
UPHOLSTERED



904.82
SOFT TOUCH



904.L2
SOFT TOUCH



9W4.S4
SOFT UPHOLSTERED



904.B4
UPHOLSTERED



H 904.91
H 904.92



h 904.76



h 904.45

LUCKY 906

design **martin ballendat**

SOFT TOUCH

Una seduta divertente.
A funny chair.

Facile da movimentare grazie alla forma dello schienale, ogni volta che la guardi sembra che ti sorrida.
The opening in the back of the design provides easy transportation of the chair.



906.21

906.51

906.81

906.01

906.B1

906.11



h 906.11
TT 216-213



h 906.51

SAILOR_INDOOR 165

design **guggenbichler design**

Una raffinata lavorazione artigianale .
A refined craftsmanship.

Alla sedia Sailor con intreccio in cima nautica, si affianca questa nuova proposta, dedicata al mondo dell'indoor, ove il cordoncino di cellulosa utilizzato riflette la cultura e la tradizione dell'utilizzo di materiali di origine naturale.

Besides the Sailor chair, with a nautical rope weave, we have this new Tonon proposal which is dedicated to the indoor world, where the used cellulose cord (also called paper cord) reflects the culture and tradition of this attention for materials of natural origin.



h 165.03
TT 248





TRIANGOLO 230

design **peter maly**

Design scandinavo.
Scandinavian touch.

Un design lineare e moderno con un tocco scandinavo caratterizza Triangolo, opera del designer Peter Maly, conosciuto a livello internazionale nel mondo del mobile.

Triangolo is a linear and modern design with a Scandinavian touch, created by Peter Maly, a designer known internationally in the world of furniture.



h 230.02
TT 230

Eleganza e semplicità.
Elegance and simplicity.

Triangolo colpisce per la sua elegante semplicità, per la curvatura dell'importante schienale in legno massello e per le gambe raccordate da un particolare incrocio: quest'ultimo è non solo un dettaglio estetico, ma anche strutturale, che rinforza la leggera costruzione.

Triangolo is striking for its elegant simplicity, for the shaping of its solid wood back and for the base with legs joined by a particular crossed structure.

TRIANGOLO 2 - ECO 230

design **peter maly**

Eco-sostenibile.
Environmentally friendly.

Triangolo ispirato dal design scandinavo è una sedia in legno massello di rovere o noce americano con una finitura a olio. Il sedile intrecciato a mano richiede circa un'ora di lavoro manuale di un' artigiano, utilizzando circa 100 metri di corda di cellulosa. L'uso di legno massello e una finitura oliata, così come il sedile in cordino di carta facile da riciclare, rendono questo prodotto eco sostenibile.

Triangolo inspired from the Scandinavian Design is a solid wooden chair in oak or in American walnut, with an oiled finish. The hand-woven seat takes about a hour of handwork of a skilled craftsman, using about 100 meters of paper cord.

The use of solid wood with an oiled finish, as well as the easily recyclable paper cord seat, make these products environmentally friendly.



MISS 151

design **guggenbichler design**

Essenziale.
Essential.

Un design essenziale e semplice rende Miss un prodotto leggero e minimalista. La sua struttura in legno si abbina al sedile imbottito, e lascia ampio respiro allo schienale aperto. Questo prodotto è impilabile.

An essential and pure design makes Miss a light and minimalist product. Its structure is in solid wood with a seat upholstered in fabric or leather.



h 151.02

MISS_2 151

design **guggenbichler design**

Cordoncino di cellulosa.
Paper cord.

Miss, sedia moderna in legno massello, con seduta intrecciata in corda di cellulosa. Come nel passato, la conoscenza dei materiali e delle loro qualità e caratteristiche intrinseche, unita ad una importante esperienza artigianale, è fondamentale per creare un prodotto gradevole e duraturo nel tempo. Un abile artigiano impiega un'ora per intrecciare un sedile, utilizzando oltre 100 metri di cordoncino di cellulosa.

Miss, a modern solid wooden chair, with a seat woven with cellulose cord. As in the past, the knowledge of materials and their intrinsic qualities and characteristics, combined with an important artisan experience, are essential to create a pleasant and long-lasting product. A skilled craftsman takes a hour to weave a seat, using over 100 meters of paper cord.



151.03

PIT&PIT2 284

design maly hoffman kahleyess

Disegno essenziale.
Essential design.

Design moderno e minimalista in legno, connubio tra design e artigianalità, in linea con la sensibilità ecologica dell'azienda. Scocca completamente rivestita e rifinita con cuciture eleganti o con la vista posteriore in multistrato. Gambe caratterizzate dalla particolare tornitura.

Modern minimalist design in wood perfect connection between design and craft, according with the green-thinking of the company. Fully upholstered shell with elegant stitching or with wooden back, legs characterized by the particular woodturning.



h 284.02
h 284.12



h 284.03

WAVE 901

design **peter maly**

UPHOLSTERED & SOFT UPHOLSTERED

Come suggerisce il nome, la forma di questa seduta richiama, attraverso le curve del sedile e dello schienale, le onde del mare. La scocca è prodotta in poliuretano schiumato e viene rivestita in tessuto o pelle.
As the name suggests, through the curves of its seat and back this chair recalls the waves of the sea. The shape is made of injected foam upholstered in fabric or leather.



h 901.16



h 901.21



901.93



901.90



901.41



901.52

WAVE STOOLS



h 901.36



h 901.94

FLOWER 9W0

design martin ballendat

Fresca ed innovativa.
Fresh and innovative.

La natura è stata da sempre la più grande fonte di ispirazione per l'uomo e diventa arte quando si riesce a coglierla e ricrearla: ecco come nasce Flower. La sua scocca richiama i petali dei fiori, rendendo omaggio alla natura con la sua forma leggiadra e strutturata.

Nature has always been the greatest source of inspiration for man and becomes art when you can grasp it and recreate it: here you are, "Flower" is born! Its shell recalls the petals of flowers, paying tribute to the nature with its graceful, structured shapes.



9W0.73/74



9W0.81



9W0.L1

9W0.11

9W0.B1



9W0.01

SALT&PEPPER 141

design **guggenbichler design**

Purezza delle forme.
Purity of shapes.

La Salt&Pepper chair è una sedia minimalista in legno con scocca dal rivestimento liscio. La forma organica della seduta si adatta al corpo umano e trasmette una bella sensazione di morbidezza, premessa di una seduta dal comfort ottimale. La bella struttura in legno massello è fornibile sia in noce americano che in rovere.

Salt&Pepper chair is a minimalistic wooden chair with a tight upholstered shell. The organic shape fits perfectly to the body giving a nice sensation of softness, premise of an optimal comfortable seating. The beautiful structure in solid wood is available in American walnut or oak.





H 141.01
TT 843

BASIC_2 926

design **tonon team**

Morbida e comoda.
Soft and comfortable.

Una collezione dove la comodità della ricca imbottitura diventa parte integrante dell'estetica del prodotto. La forma geometrica leggermente smussata, transcende le mode per inserirsi come prodotto capace di adattarsi tra diversi ambienti e stili. La maestria della tappezzeria conferisce all'occhio e al tatto una sensazione di assoluta morbidezza.

A collection where the comfort of the rich padding becomes an integral part of the product's aesthetic. The smooth geometric shape transcends all trends to become a product that is versatile enough to fit different environments and styles. The upholstery offers a sensation of exquisite softness.



H 926.82
H 926.92
TT 257



h 926.91

SHELLS 945

design martin ballendat

Shells nasce dalla collaborazione tra il settore dell'arredamento e quello della maglieria. Lo schienale è infatti formato da una maglia leggermente elastica, che avvolge la schiena e si adatta alla forma del corpo. Il perfetto grado di tensione ha reso possibile la realizzazione di una seduta originale e confortevole.

Shells was born from a collaboration between the furniture and knitwear sectors. The backrest is in fact made up of a slightly elastic mesh, which wraps around the back and adapts to the shape of the body. The perfect degree of tension made it possible to create an original and comfortable product.



h 945.B1



h 945.82

CLUB 048

design christian heimberger

Linee morbide.
Soft lines.

Club con le sue misure contenute è capace di adattarsi all'interno dell'ambiente domestico e non solo: diventa una piacevole seduta nell'area lounge dell'hotel oppure per la piccola sala riunione. La "Club" è proposta pure con un'extra imbottitura, per una sensazione "super soft" ancora più gradevole ed invitante allo sguardo.

The petit size of Club makes it ideal for adapting to both home environments and corporate spaces, such as lounge areas in a hotel or small meeting areas. The "Club" is also offered with extra padding, for a "super soft" feeling that is even more pleasant and inviting to the eye.

UPHOLSTERED



048.71



048.B1



048.91

SOFT UPHOLSTERED



048.72



048.B2



048.92



H 048.71

FUSION 044

design **stephan veit**

Petite.
Petite.

Le forme tondeggianti e ricche della poltrona "Fusion" conferiscono allo sguardo proprio quella morbidezza ricercata che garantisce comfort ed ergonomia. La sua dimensione petit la rende adatta nella piccola sala da pranzo attorno ad un tavolo, o in una piccola sala riunione dove sia importante utilizzare al meglio gli spazi.

The rounded and soft shapes of "Fusion" provides the armchair with a look of refined softness that will guarantee ergonomic comfort. Due to its small size, Fusion is suitable for compact dining rooms and meeting rooms, where it is important to make the most of the space.



044.B1



044.B2

WINE 039

design **gugghenbichler design**

Una poltroncina dalle forme decise e avvolgenti.

An armchair with decisive and enveloping shapes.

Le sue dimensioni contenute la rendono adatta alla sala da pranzo, allo studio, alla camera da letto, conferendo ad ogni ambiente un tocco chic e caldo: proprio come un buon bicchiere di vino. La nuova versione si propone con un'imbottitura extra, che la rende ancora più morbida e confortevole.

Its small size makes it suitable for a dining room, home office or bedroom, giving every interior a chic and "warm" feeling, much like a good glass of wine. The new version comes with extra padding, which makes it even softer and more comfortable.

UPHOLSTERED



039.42



039.91



039.71

SOFT UPHOLSTERED



039.72



039.92



039.43

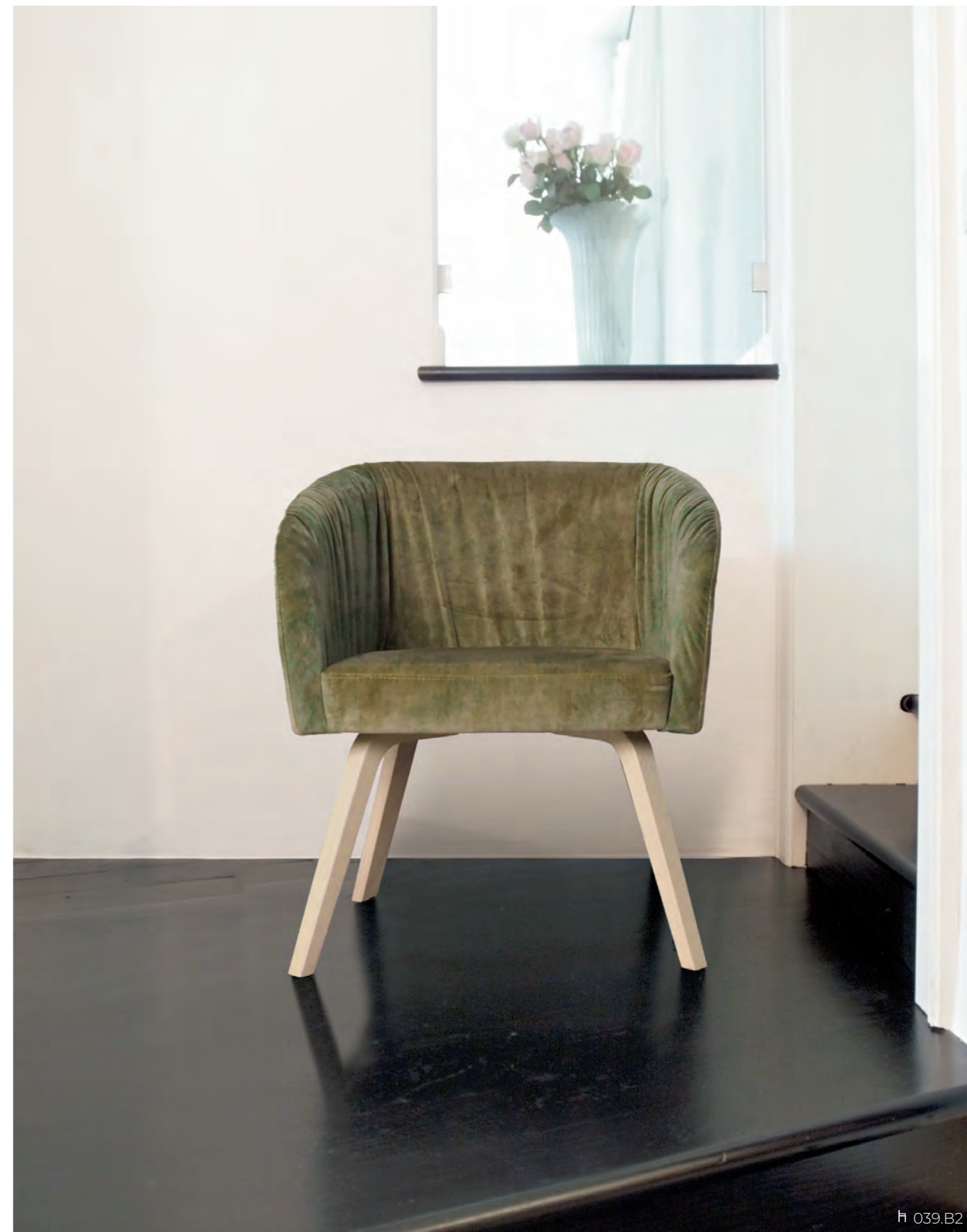

H 039.B2

TENDENCE 140

design **lepper schmidt sommerlade**

Raffinata nella sua semplicità.
Refined in its simplicity.

La collezione Tendencia è prodotta in legno massello di faggio. Presenta un elemento di raccordo tra lo schienale e le gambe posteriori, in acciaio cromato opaco, che caratterizza lo stile della collezione.

The Tendencia collection is produced in solid beech wood. It has a connecting element in matt chromed steel between the backrest and the rear legs, which characterizes the style of the collection.



FANCY 227

design christian werner

UPHOLSTERED & SOFT UPHOLSTERED

Le sue linee essenziali e smussate arredano ambienti moderni e classici. Schienale e seduta sono realizzati in poliuretano schiumato a freddo, un materiale dagli alti standard qualitativi. Lo schienale della "Fancy" è disponibile con un'extra imbottitura: ulteriore morbidezza che si abbina all'estetica che la contraddistingue.

Fancy features rounded lines, perfect for furnishing both modern and classic environments. The backrest and seat are made from injected polyurethane foam, an extremely high-quality material. The backrest is also available with extra padding to offer the highest level of comfort.



h 227.11



h 2W7.12



H 227.92
TT 277

SWING & SWING LIGHT 967/ 985

design lepper_schmidt_sommerlade

Due versioni.
Two versions.

La sedia Swing è disponibile in due versioni: con fusto in tubo d'acciaio a sezione rettangolare oppure piatto pieno.
The cantilever chair Swing is available in two versions: frame with rectangular hollow steel section or in flat solid steel.



FOR US 509

design **tonon team**

Prodotto dedicato.
Customized product.

La lunghezza minima è di un metro e può arrivare fino tre metri; non necessita di ulteriori basi di appoggio. Il basamento è fornibile laccato nero opaco. Per il rivestimento del sedile e dello schienale in poliuretano è disponibile un'ampia gamma di tessuti e di pelli.

The minimum length is one meter and can be supplied up to a maximum length of three meters without extra support leg. The base is painted black. A wide range of fabrics and leathers are available for the polyurethane seat and back upholstery.

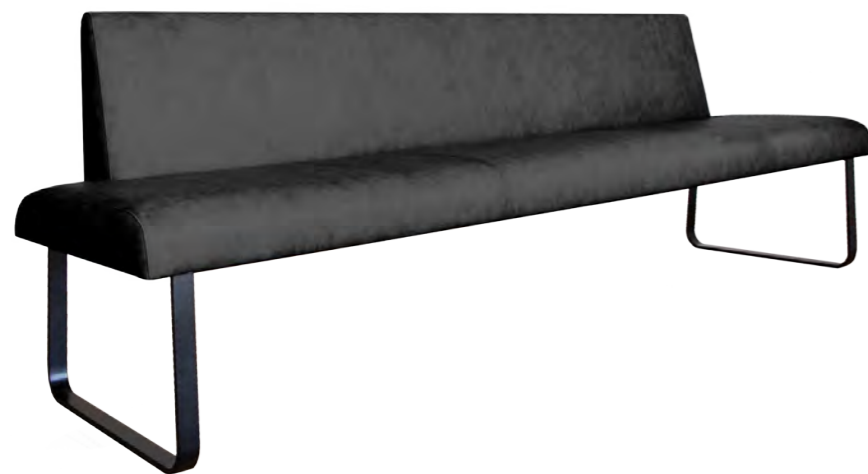

h 967.71
F 509
TT 848

FOR US SOFT UPHOLSTERED 5W9

design **tonon team**

Morbida non solo allo sguardo.
Soft not only to the look.

Anche la versione "soft" viene proposta come prodotto su misura. Quando la lunghezza supera i tre metri viene inserita, sotto la seduta, una slitta centrale di supporto in acciaio.

The "soft" version is also available as a custom-made product. When the length exceeds three meters, a central steel support slide is inserted under the seat.



H 1W7.03
P 5W9
TT 849

GAMMA 955

design **martin ballendat**

Una seduta moderna.
A modern chair.

Legno, metallo e tessuto compongono questa seduta dalla forma rigorosa. Lo schienale in compensato curvato, caratterizzato da un'ampia apertura centrale, conferisce una sensazione di leggerezza.
Wood, metal, and fabric make up this square-shaped chair. The bent plywood backrest, characterized by a wide central opening, gives a feeling of lightness.



H 955.02
TT 839

LILI 1W7

design **veit streitenberger**

Comoda e morbida.
Comfortable and soft.

Lili è una poltroncina moderna. Lo schienale leggermente aperto la rende un prodotto facile da spostare nei diversi ambienti; unito ai braccioli, conferisce una seduta avvolgente e comoda.

Lili is a modern armchair. The slightly open backrest makes the product easy to move to different locations. Combining the backrest with the armrests, the result is an enveloping and comfortable seat.



SPRING 170

design **martin ballendat**

Tre diversi schienalini.
Three different small-backrests.

Questi vengono realizzati con un intreccio in cordoncino in poliestere, oppure con un compensato che lascia intravedere le venature del legno oppure con una sottile imbottitura applicata sul suo lato interno.
The backrests are made with a woven polyester rope or with a plywood panel that allows you to see the grain of the wood or with a fine padding applied on the inner side of the plywood panel.



Una struttura leggera e delicata.
A refined craftsmanship.

La sedia Spring ha una sottile struttura in metallo, che rende visivamente una sensazione di ricercata leggerezza; è caratterizzata da un sedile molto confortevole grazie alle cinghie elastiche e da uno schienale che proponiamo in tre varianti.
The Spring chair has a thin metal structure that visually gives a sensation of refined lightness; it is characterized by a very comfortable seat, thanks to the elastic belts, and by a backrest offered in three variants.

SELLA 290

design **peter maly**

Combinazione di materiali.
Combination of materials.

L'unione del legno massello con l'acciaio e il cuoio danno a questo sgabello un profilo di grande immagine.
The combination of solid wood with steel and leather gives this stool a profile of great image.



Una sedia disegnata da Peter Maly,
con l'obiettivo di offrire una
soluzione d'arredo completa per gli
interni del settore alberghiero.

This chair has been designed by
Peter Maly with the aim of offering a
complete furnishing solution for the
interiors of the hotel sector.



BRAND 912

design martin ballendat

Essenziale.
Essential.

Linee squadrate e nette che parlano la lingua dell'essenzialità. La struttura in metallo e l'imbottitura rendono Brand un prodotto adatto ad ambienti minimal.

Brand is an essential product that offers square and clear lines. The metal structure and padding makes Brand suitable for minimalist locations.



912.11

912.12



LIBRA COLLECTION 298

design **matteo nunziati**

Una collezione senza tempo.
A timeless collection.

Matteo Nunziati è specializzato nella progettazione di hotel di lusso e residenze di altissimo livello in tutto il mondo. Insieme con Tonon ha ideato un programma di sedute (sedia, poltrona, lounge, divano e tavoli) che possano inserirsi sia nell'habitat che in aree pubbliche come ristoranti, zone di attesa oppure stanze d'albergo. La collezione Libra è di grande eleganza formale, abbinata ad un comfort rassicurante e di qualità.

Matteo Nunziati is specialized in the design of luxury hotels and high end residences all over the world. Together with Tonon he has created a program (chair, armchair, lounge, sofa, stool and tables) that can fit both in the habitat and in public areas, such as restaurants, waiting areas or hotel rooms. The Libra collection is of great formal elegance, combined with a reassuring comfort and quality.



H 298.01
T 298.65



H 298.11



H 298.41



F 298.21
F 298.51
TT libra coffe tables

LIBRA STEEL LEGS 298

design **matteo nunziati**

Una nuova variante per le sedie Libra.
A new version for the Libra chairs.

La collezione di successo del designer Matteo Nunziati si arricchisce di ulteriori varianti. Libra incarna eleganza formale e comfort elevato. Le forme equilibrate e pulite si uniscono alle generose imbottiture che offrono il massimo del comfort; ora vengono proposte anche con un interessante telaio in acciaio.

The successful Libra collection designed by Matteo Nunziati has been enriched with new variants. Libra embodies formal elegance and high comfort. The balanced and clean shapes are combined with the generous padding that offer maximum comfort and are now proposed also with an interesting steel frame.





H 298.03
TT 257

H 298.13

CHIC 153

design **cuno frommherz**

Chic è chic.
Chic is chic.

Chic è una seduta moderna con una struttura in pregiato noce massello, caratterizzata da una particolare attenzione alle proporzioni che si armonizzano con l'imbottitura dello schienale e dei braccioli.
Chic is a modern chair in solid wood, with a particular focus on its proportions, which harmonizes perfectly with the padding of the back and armrests.



H 153.11



TIMELESS 661

design **paolo nava**

Ispirazione scandinava.
Scandinavian inspiration.

La poltroncina Timeless si ispira al disegno scandinavo che si riconosce per i suoi principi minimalisti quali le forme essenziali e l'utilizzo di elementi naturali come il legno.
The "Timeless" armchair is inspired by Scandinavian design, which is recognized for its minimalist principles, such as essential shapes and the use of natural elements, such as wood.



661.01



h 661.04
TT 232

TIMELESS_2 661

design **paolo nava**

100% naturale.
100% natural.

Materiali semplici da reperire e uso sostenibile delle risorse sono le caratteristiche fondamentali dell'intreccio. Il cordoncino di cellulosa che noi utilizziamo è di origine naturale e quindi riciclabile.

Simple and sustainable materials to find in the surrounding with respect of the natural resources, these are the fundamental characteristics of the interweaving. The cellulose paper cord we use is of natural origin and consequently recyclable.



661.05



JONATHAN 30 004

design **paolo nava**

Una lunga storia.
A long history.

Ispirata alla classica Thonet, il cui elemento principe è un sedile in legno curvato di forma rotonda, Paolo Nava disegnò nel 1983 un modello capace di armonizzare modernità e tradizione, rivisitandolo poi a trent'anni di distanza con materiali innovativi e forme più ampie. Sedile e schienale sono formati da due elementi ovali di forma identica, uniti con un elemento in pressofusione di alluminio, che ha anche una sua validità estetica, riportando il nome della seduta e quello dell'azienda.

Inspired by the classic Thonet chair, whose main element is a bent wooden seat with a round shape. Paolo Nava designed Jonathan in 1983, a model capable of harmonizing modernity and tradition, revisiting it thirty years later with innovative materials and wider shapes. The seat and back are made up of two oval elements with identical shapes, joined through an element in die-cast aluminum, which bears both the name of the product and the company.



004.25



h 004.25
TT 216

WIND 215

design martin ballendat

Senza Tempo.
Timeless.

Lo schienale curvo e imbottito della sedia Wind si abbina a un'ampia e ariosa apertura, che rende la seduta leggera e confortevole. L'elemento naturale del legno conferisce un gusto senza tempo. Forme semplici e organiche conciliano la ricerca di un prodotto discreto e funzionale.

The curved and padded back of the Wind chair is combined with a wide and airy opening, which makes the seat light and comfortable. The natural element of wood gives it a timeless aesthetic. Combining simple and organic shapes result in a discreet and functional product.



Bilanciamento tra fascino del passato e stile di vita del presente.

Balance between the charm of the past and the lifestyle of the present time.



H 215,01
TT 839

PICCOLA KETTY 219

design **tonon team**

Leggera e armoniosa.
Light and harmonious.

Attraverso linee pulite e una ricercata funzionalità, questo prodotto arreda con sobrietà ambienti moderni e classici. La scocca, formata da sedile e schienale imbottiti e piacevolmente accostati, poggia su una base formata da un anello in acciaio, con quattro sottili gambe slanciate.

Clean lines and functionality, this product furnishes modern and classic environments together. The shell, consisting of a padded seat and back, rests on a base made up of a steel ring, with four slimline legs.



LORD GERRIT COLLECTION 221

design **gabriela raible**

Una collezione dal gusto classico.
A collection with a classic touch.

Ideata per la ristorazione ed il settore alberghiero, che necessitano di prodotti durevoli per un utilizzo costante, la collezione si presenta con strutture affidabili e solide, mentre il suo design si concentra su forme slanciate e squadrate.

Lord Gerrit is a collection with a classic touch. Developed for the hospitality industry, which requires durable products for regular use, the collection has solid and reliable structures, while its design focuses on slim and square shapes.



h 221.03
h 221.04
TT 257

Anche su misura.
Also bespoke.

Il divano, che proponiamo in due dimensioni, è stato progettato anche per una possibile realizzazione su misura, in base agli spazi disponibili.

The sofa we propose is in two sizes and is also possible in a bespoke manufacturing according to the related spaces.



221 SOFA



221.81 STOOL

Un'ampia poltrona, dal disegno neutro, dove i cuscini possono essere realizzati anche in colori e materiali diversi.

A large armchair, with a neutral design, where the cushions can also be made in different colors and materials.



221.41 LOUNGE

Classico ed elegante.
Classic and elegant.

Le varianti del divano e della lounge con schienale alto, riflettono il background culturale di Gabriel Raible che si esprime in linee e forme classiche, perfette nelle proporzioni e di estrema eleganza
The high back versions of the sofa and the lounge of the Lord Gerrit collection, reflect Gabriel Raible's cultural background which is expressed in classic lines and shapes, perfect in proportions and extremely elegant.



221 SOFA HIGH BACK



221.42 LOUNGE HIGH BACK

EUTHALIA 181

design **matteo nunziati**

Una struttura in legno, con un'imbottitura confortevole.
A solid wood structure with excellent comfort.

Euthalia è una seduta dall'aspetto importante. Le sezioni del legno massello rendono il prodotto robusto e stabile e mantengono un'estetica piacevole.

Euthalia chair has been created from solid wood, making the products sturdy and stable and maintaining a harmonious and pleasant aesthetic throughout.



FRIENDLY 144

design **tonon team**

Passione per il legno.
Love for the wood.

Friendly richiama la tradizionale lavorazione del legno con un tocco fresco e gioviale. La dolce curvatura dello schienale in legno viene esaltata dalla sua forma tondeggiante; la verniciatura all'acqua valorizza i colori e le venature del legno, donandole un "finish" naturale.

Friendly recalls the traditional woodworking, offering a fresh and jovial aesthetic. The curved wooden back is enhanced by its rounded shape. The water-based finish enrich the colors and wood grain, giving them a natural touch.

H 144.01
H 144.11
H 144.41



FRIENDLY 2 144

design **tonon team**

Dal passato al presente.
From the Past to Present.

Friendly è realizzata in legno massello di rovere o noce americano e ha una finitura a olio. Il sedile intrecciato a mano richiede circa un'ora di lavoro manuale, utilizzando circa 100 metri di corda di cellulosa. L'uso di legno massello e una finitura oliata, così come il sedile in cordino di carta facilmente riciclabile, rendono questo prodotto eco sostenibile.

Friendly is made in solid wood, oak or American walnut, and has an oiled finish. The hand-woven seat takes about a hour of handwork, using about 100 meters of paper cord.

The use of solid wood with an oiled finish, as well as the easily recyclable paper cord seat, make these products environmentally friendly.



144.03

ENSEMBLE 941

design martin ballendat

Piace sempre.
Always appreciated.

Un modello di successo da tanti anni, per la pulizia del suo disegno, per la morbida scocca in schiumato, per lo schienale che, grazie alla sua flessibilità, assicura sempre un ottimo comfort. In questa foto potete apprezzarla assieme alla sua poltroncina.
A model of success since many years, for its neat design, for the soft injected foam shell, for the backrest which always ensures a great comfort due to its flexibility.



h 941.02
h 941.12



GALLANT 344

design **studio borella**

Equilibrio e armonia.
Balance and harmony.

Le gambe in massello di noce canaletto e la struttura con una imbottitura particolare con rivestimento in pelle o tessuto la rendono un prodotto formale, adatto ad ambienti caratterizzati da uno stile classico.

The legs in solid American walnut and the structure features padding upholstered in leather or fabric, making it a formal product that is suitable for environments characterized by a classic style.



BERET 301

design **gabriela raible**

L'eleganza al primo posto.
Elegance first.

Beret: un programma di sedute per la zona giorno che sa diventare protagonista anche in altre zone dell' habitat quotidiano e nelle aree della ristorazione. Ideata da Gabriela Raible, la collezione si articola in molteplici elementi accomunati da grande eleganza formale, abbinati ad un comfort rassicurante e di grande qualità.

Beret: a set of seating solutions for the living that can be a protagonist also in other areas of the daily habitat and as well for the restaurants. Created by Gabriela Raible, the collection is made by many elements joined by a great stylish elegance enriched by a high quality comfort.



301.02



301.12



301.22



301.41





H 301.01
H 301.12



Le sedute della collezione Beret, come del resto tutte le altre collezioni, possono essere rivestite con materiali inviati dai clienti.
The seats of the Beret collection, like all the other collections, can be upholstered with customer's own material.



I rivestimenti.
The upholstery.

Le sedute, con le loro linee curve e pulite, vengono rivestite in tessuto o pelle e il confezionamento talvolta si arricchisce di cuciture sulla seduta.
The seats, with their curved and clean lines, are covered in fabric or leather. The look is enriched with stitching on the seat.



PRINCESS 128

design **fabrizio gallinaro**



Stile essenziale ed elegante.
Essential and elegant style.

Ampio programma senza tempo di sedute imbottite con struttura in legno massello, con una lieve e discreta influenza del neoclassicismo. Wide timeless set of upholstered chairs with solid wood frame, with light and discreet influence from the neoclassicism.

H 128.02
H 128.12
H 128.42



Sia con la sedia che con quella con i braccioli, che con lo sgabello per il piano bar, la collezione Princess copre tutte le destinazioni d'arredo importanti.

Collection comprising of: chair and armchair with wooden armrests and a barstool. The Princess collection is a must for an elegant interior solution.

SIGNATURES 302

design **carrol design**

Una seduta elegante.
Elegance first.

La collezione Signatures si fa strada tra ambienti moderni e retrò e si presta ad arredare con classe eleganti sale da pranzo anziché ristoranti esclusivi. Interessante è lo schienale, che viene proposto con un'imbottitura "trapuntata", più moderna oppure in capitonné, tradizionale e classico.

The style of the Signatures collection is between modern and retro and lends itself to furnish elegant dining rooms rather than exclusive restaurants. The backrest is offered with a modern 'quilted' padding or in a traditional and classic capitonné.



302.26



SPIRIT 404

design **annette lang**

Eleganza & Comodità.
Elegance & Comfort.

La sedia Spirit, qui proposta con le sue poltroncine, è disponibile con un'imbottitura moderna morbida e confortevole o con classico capitonné.

The Spirit chair, here proposed with its armchairs, is available with a soft and comfortable modern padding or with classic capitonné.



H 404.01
H 404.11



404.33 LOUNGE CHAIR



CHARMING 388

design **annette lang**

Una seduta classica.
A classic product.

Un suo perfetto abbinamento, grazie all'alto schienale, è con un tavolo importante, per creare una gradevole atmosfera formale nella sala da pranzo.
Thanks to the high back it's a perfect match with an important table in order to create a pleasant formal atmosphere in the dining room.

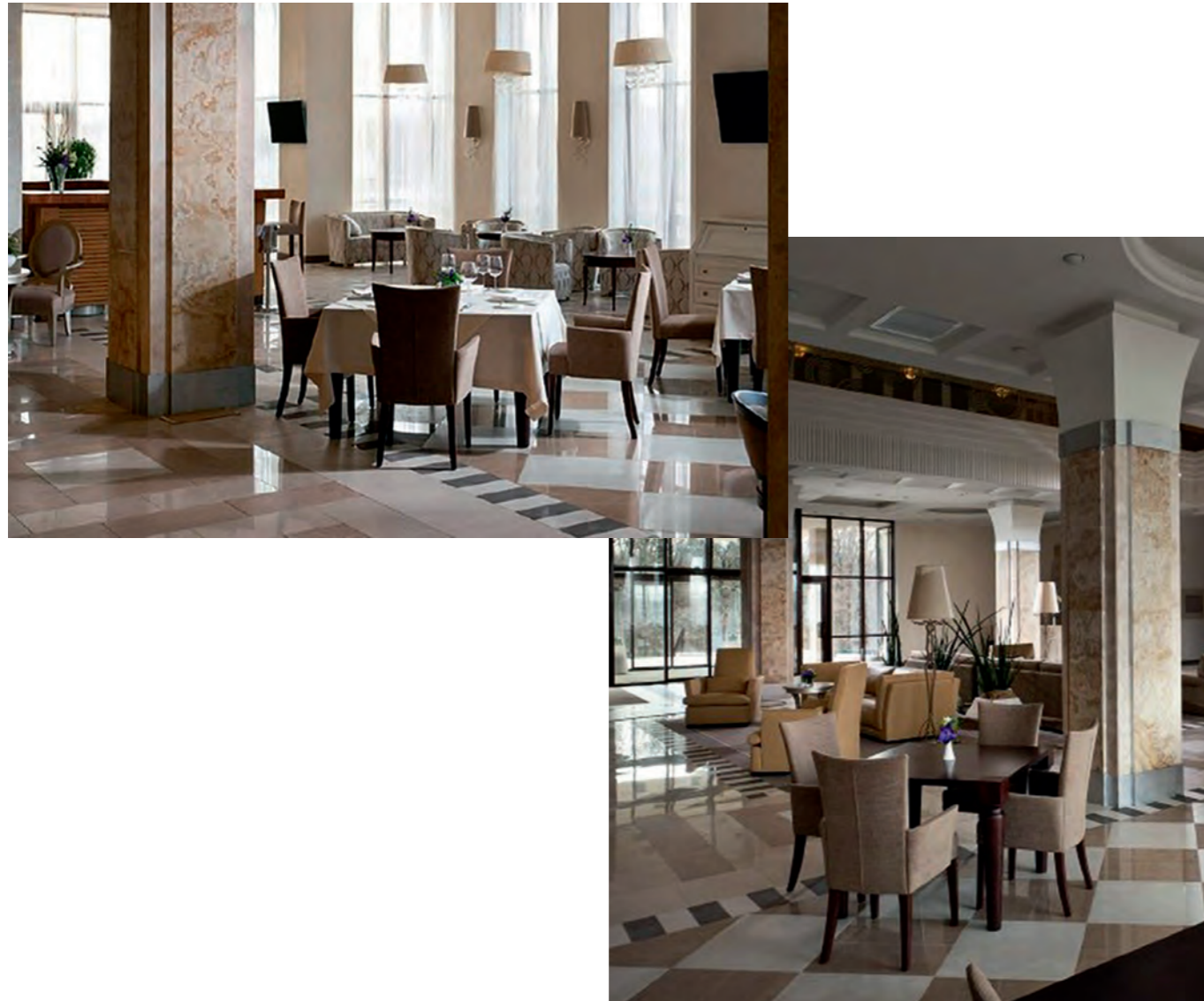

h 388.01
h 388.05

VILLA 323

design **edi e paolo ciani**

Formale.
Formal.

Una collezione dai tratti formali, in cui si riconosce l'arte della lavorazione del legno tipica del territorio. La struttura in massello di faggio si abbina ad una imbottitura confortevole, arredando ristoranti ed hotel raffinati.

A collection with formal features, in which you can recognize the art of woodworking typical of the territory. The structure in solid beech wood is combined with a comfortable padding, ideal for furnishing restaurants and refined hotels.



H 323.01

H 323.11

H 323.41



SAILOR COLLECTION 165

design **guggenbichler design**

IN&OUTDOOR

Impilabile, leggera e resistente.
Stackable, light and resistant.

Sailor è una collezione composta da sedia, sgabello e lounge. Tutti i prodotti di questa linea sono impilabili. Invece della tradizionale tecnica intrecciata usata per le sedute, il design si ispira alle reti dei pescatori, che vengono associate al sole, alla spiaggia e all'acqua di mare. Le corde nautiche in poliestere e le strutture in acciaio sono resistenti alle intemperie, sia nella stagione fredda che in quella calda. Pensiamo al nostro mondo! Sailor è un prodotto durevole che richiede poca manutenzione, è realizzato con materiali riciclabili provenienti da aziende locali.

Sailor is a collection made of chair, barstool and lounge. All products of this line are stackable. Instead of the traditional rope braiding techniques for seating products, the design is inspired by fishermen nets, which are connected with the sun, beach and sea water. The polyester nautical ropes and the steel frames are weather resistant, both in cold and hot season. We think to our world! Sailor is a durable product and has low maintenance requirements, it's made with recyclable materials, which are produced by local manufacturers.



165.01  x5



165.21



165.41/42  x5



Sailor coffee table
Piano in HPL.
HPL top.
165.61: Ø 110 cm; h= 39 cm





H 165.21
TT 165.61



Che sia per outdoor, dove la pioggia, il sole, il vento e l'umidità sono nemici assoluti dei mobili. Che sia per una casa, un ristorante, un pub. In qualsiasi ambiente si trovi, la versatilità della Sailor e il suo design accattivante daranno prova di sé.

Whether for outdoors, where rain, sun, wind and humidity are absolute enemies of furniture. Whether it's for a home, a hotel, a restaurant, a pub. Whatever environment it's in, the versatility of Sailor and its attractive design will be emphasized.



h 165.42
TT 162.75



H 165.01
TT 248.40

SAILOR TABLE 165

design guggenbichler design



CORDA COLLECTION 162

design **cuno frommherz**

IN&OUTDOOR

CHAIRS, ARMCHAIRS, STOOLS, BENCHES, LOUNGES, TABLES

Una collezione dal linguaggio mediterraneo.
A collection with a Mediterranean language.





H 162.02
H 162.31
TT 257



h 162.02
h 162.32



h 162.42
h 162.75



Una panca per il tavolo da pranzo.
Il programma Corda si arricchisce di una panca da pranzo.
A bench for the dining table.
The Corda program gets enriched by a dining bench.



H 162.02
h 162.32
H 162.75/76
TT 248.40



Sulla struttura in acciaio verniciato viene intrecciata una cima nautica che offre un supporto portante alla seduta ed allo schienale. A richiesta sono disponibili comodi cuscini imbottiti.
The mat lacquered metal frame is woven with a nautical rope which forms the supporting structure of the seat and back.
On request comfortable upholstered cushions are available.



Intreccio fatto a mano.
hand made weaving.

Proponiamo due tipi diversi di intrecci in cima nautica:

quello più semplice, quadrettato e quello più elaborato, realizzato con cime nautiche elastiche, per offrire in aggiunta il massimo comfort.

We offer two different types of nautical ropes for the weaving: the more simple version is checkered and with non elastic nautical ropes and the more elaborate version is woven with elastic nautical ropes, in order to offer still more comfort.

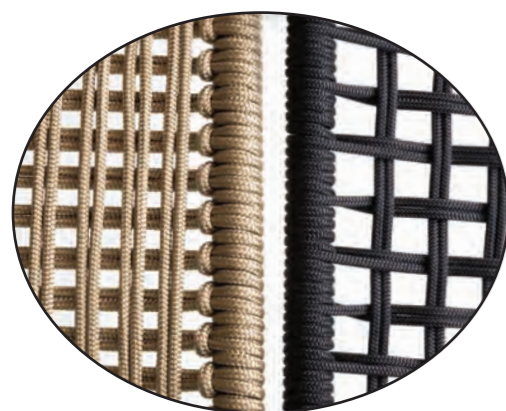

162.02
162.12
162.22
162.42/52
162.75

162.01
162.11
162.21
162.31
162.41/51
162.71



162.01 h x5
162.02 h x5

162.11 h x5
162.12 h x5

162.31

162.41/51 h x5
162.42/52 h x5



162.21 h x5
162.22 h x5

162.71/72 h x5

162.75/76 h x5

CORDA TABLES

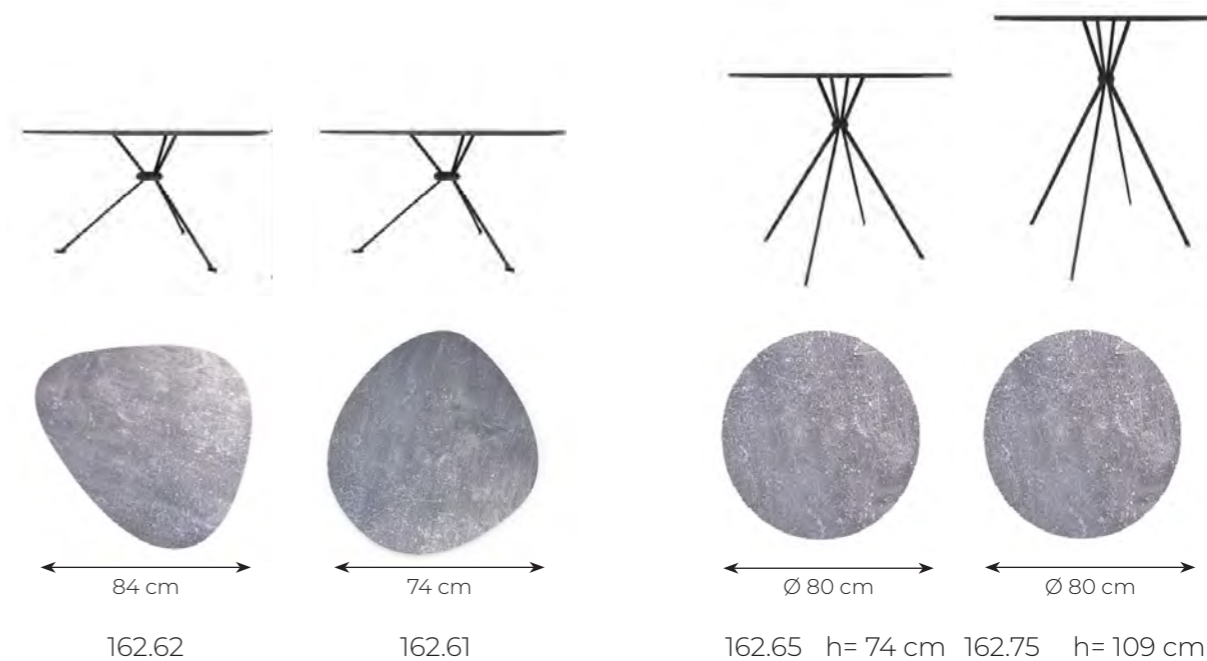

84 cm
162.62

74 cm
162.61

Ø 80 cm
162.65 h= 74 cm

Ø 80 cm
162.75 h= 109 cm

CORDA TABLES 162

design **cuno frommherz**

Differenti misure.
Different measures.

Corda è un ampio programma nel quale troviamo tavoli utilizzabili sia per l'interno che per l'esterno.
Corda tables can be used for both indoor and outdoor use.



Il piano.
The top.

I piani in HPL, disponibili in forme diverse, sono in grado di resistere ai raggi UV e agli agenti atmosferici.
The HPL tops are available in different shapes, they are able to resist UV rays and atmospheric agents.



RIVER COLLECTION 903

design **mac stopa**

Ispirata alla natura.
Inspired by nature.

La collezione River è un omaggio alla natura: ispirandosi alle forme organiche della sabbia nel bagnasciuga del mare, scolpito dal vento e dall'acqua, il designer Mac Stopa ha realizzato un ampio programma di sedute con geometrie tridimensionali moderne e originali. La collezione è composta da sedia, lounge, tavolino da caffè e due diversi pouf.

The River collection is a tribute to nature: inspired by the organic shapes of the sand on the shore of the sea, sculpted by the wind and water, the designer Mac Stopa has created a wide range of seats with modern and original three-dimensional geometries. The collection consists of a chair, lounge, two different poufs and coffee table.



903.60 RIVER COFFEE TABLE

903.21 RIVERSIDE



903.00 RIVER STONE
903.05 SMALL RIVER STONE

Un materiale con alte prestazioni tecniche.
An high performance material.

La collezione è realizzata in "soft touch plus", un poliuretano flessibile morbido con una membrana esterna colorata, compatta ed elastica. Questo materiale è estremamente resistente, impermeabile, ignifugo e certificato per essere sanificato e pulito con candeggina diluita in acqua, senza causare alcuna usura alla superficie.

The collection is made of "soft touch plus", a soft flexible colorful, compact polyurethane material, with an elastic external membrane. This material is extremely durable, waterproof, fireproof and certified to be sanitized and cleaned with bleach diluted in water, without causing any damage to the surface.



Riverside, una forma unica.
Riverside, a unique shape.



903.05 SMALL RIVER STONE



903.00 RIVER STONE

Molteplici destinazioni.
Multiple destinations.

Dinamismo è il termine che descrive al meglio la collezione River. Grazie alla sua versatilità è perfetta in giardini e terrazze, in concept outdoor di ristoranti e caffetterie e pure in SPA, centri wellness e piscine, dove la presenza di acqua e umidità rendono spesso delicato il mantenimento dei complementi d'arredo.

Dynamism is the term which best describes the River collection. Thanks to its versatility it is perfect in gardens and terraces, in outdoor concepts of restaurants and cafes and also in SPA, wellness centers and swimming pools, where the presence of water and humidity often makes the maintenance of furniture difficult.





903.00
TT 216-213





903.11 RIVER CHAIR



903.10 RIVER SNAKE



LOFT 085

design **markus kerker**

UPHOLSTERED & SOFT UPHOLSTERED

Relax.
Relax.

La seduta ergonomica di Loft invita al relax. Le linee curve, l'imbottitura al suo interno e l'amore per i dettagli danno a Loft un carattere unico che, abbinato a una raffinatezza molto discreta, convince qualsiasi amante del Design.
The ergonomic seating of Loft invites to relax. The rounded lines, the inside padding and the attention to details give to loft a unique character which, combined with a very delicated refinement, convinces every design-lovers.



H 085.03 + 085.42





H 085.03 + 085.42
531 lampada



h 085.13 + 085.52
TT 232.01+232.11
531 lampada

UP WOOD 917

design martin ballendat

Proporzioni perfette.
Perfect proportions.

La collezione Up Chair, la preferita dal pubblico, viene ampliata anche nella sua versione più nobile. Una poltrona lounge e un divanetto con braccioli in legno massello, dalla lavorazione artigianale, e una scocca in schiumato, imbottita, nata dalla creatività di Martin Ballendat. Il legno di noce massello americano rende questi prodotti di grande classe e prestigio. L'ampia collezione di pelli Tonon offre la possibilità di trovare la giusta combinazione di colori in base al proprio gusto personale.

The public favorite Up chair collection, is increasing even in its noblest version. A lounge and sofa with handcrafted armrests in solid wood and upholstered shell, born from the creativeness of Martin Ballendat. The solid American walnut gives this lounge and sofa a remarkable style. The wide collections of leathers offered by Tonon, gives to any style the possibility to find their right colors combination.



h 91728
TT 91745



917.51



917.35



QUESTION MARK 046

design **stefan heiliger**

Un impatto visivo indimenticabile.
An unforgettable visual impact.

Stefan Heiliger ha realizzato, con la Question Mark, un prodotto iconico che risalta in ogni ambiente.
Stefan Heiliger with the Question Mark, has created an iconic product that stands out in any environment.



046.01



046.41 STOOL



MATCHBALL 064

design **lepper schmidt sommerlade**

Linee tonde.
Round lines.

Contenuta nelle dimensioni, è ideale sia nelle sale d'attesa sia in un salotto. La ricca imbottitura la rende accogliente e piacevole.

Small in size, it is ideal for waiting and living rooms. The rich padding makes it a cosy and welcoming armchair.



064.01



H 064.01
TT 851

FIRST CLASS 090

design **markus kerker**

Smart working e relax.
Smart working and relax.

Firstclass nasce come poltrona capace di combinare relax e lavoro: presenta infatti un pianetto rigido dove si può comodamente appoggiare il computer, il tablet o un libro.

Firstclass was born as an armchair, capable of combining relaxation and work, thanks to its sturdy tabletop where you can place your computer, tablet, or a book.



090.01



GLOBE 408

design **mathias hoffman**

Un prodotto molto accogliente.
A very welcoming product.

Lo stile fresco, giovanile di Globe si valorizza al meglio quando abbinato a rivestimenti dai colori accesi.
The best way to enhance Globe is to dress it in bright colors.



PYRAMID 037

design **peter maly**

Una lounge elegante e moderna.
An elegant and modern lounge chair.

Forme squadrate caratterizzano questa collezione che consiste in una lounge e un divano. Uno stile deciso e allo stesso tempo capace di adattarsi in ambienti moderni.

Square shapes characterize this collection which consists of a lounge and a sofa. A decisive style, which is also capable of adapting to modern environments.



037.73



037.01



037.21



PYRAMID SOFA

h 037

LADY 045

design **isabelle rigal**

Femminile e sensuale.
Feminine and sensual.

Lady è una poltroncina dalle misure contenute e dal gusto "timeless". La forma sofisticata si combina a una ricca tappezzeria ed è disponibile in 2 versioni: liscia o "super soft".

"Lady", an armchair with small dimensions and a timeless design. The sophisticated shape is combined with a rich upholstery and is available in two versions: smooth or "super soft".



045.01



H 045.11
H 045.12
TT 232.01

FLY TOO 063

design **guggenbichler design**

Linee decise.
Strong lines.

Fly too è una poltrona con un disegno dinamico. La spigolosità della forma si combina alla morbidezza dell'imbottitura, creando un prodotto moderno e allegro.

Fly Too is an armchair with decisive and dynamic shapes. The angularity of the shape, combined with the softness of the padding, creates a modern product.

UPHOLSTERED



063.B1



063.21



063.01

SOFT UPHOLSTERED



063.B2



063.22



063.02



063.21

ANTHEIA 049

design **jackie choi**

Linee morbide e ricche.
Soft and rich lines.

Antheia era una delle grazie della mitologia greca, la dea dei fiori. Simbolo di freschezza e accoglienza, le abbiamo voluto rendere omaggio con questa poltroncina dalla forma originale.

Antheia was the Goddess of Flowers, according to Greek mythology. A symbol of freshness and hospitality, we wanted to pay tribute to her with this armchair and its original shape.

UPHOLSTERED



049.43



049.93



049.B1

SOFT UPHOLSTERED



049.44



049.94



049.B2



4-METER TABLE 248

design **thomas althaus**

Riproponiamo, con un nuovo sistema di allunghe, questo interessante tavolo disegnato nello scorso millennio da Thomas Althaus. Quando completamente aperto 12 ospiti trovano comodamente posto. La struttura è in acciaio verniciato e il piano può essere in Fenix "total black" oppure in HPL con due allunghe in Fenix nero. Il tavolo può essere allungato a piacimento per diverse situazioni, fornendo spazio extra per cibi e bevande. Perfetto per le piccole famiglie con tanti amici come per le grandi famiglie quando, con dispiacere, non sempre riescono ad ospitare tutti attorno ad un tavolo.

Thanks to a small restyling and a new extendable mechanism, a new interesting table was born, designed by Thomas Althaus at the end of the last century. The structure is made of painted steel, the top can be in "total black" Fenix or in HPL, with two black Fenix extensions. The "4-meter table", which is very current today, offers comfortable space for 12 guests when extended.

The table can be lengthened as required for different situations, giving additional space for food and drinks. It is perfect for small families with many friends, as well as for large families where, unfortunately, it is not always possible to seat everyone at one table.



H 165.03
TT 248.40

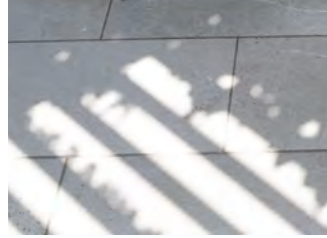

STEEL TABLE 827

design **tonon team**

Presenza scultorea.
Sculptural presence.

Un Design senza tempo contraddistingue Steel table. L'interessante combinazione dei piani con la moderna base a cavalletto in acciaio conferisce al tavolo un aspetto lineare ed elegante. I piani tavolo in legno sono fornibili, con tempi di consegna più lunghi, anche su misura.

Steel table, a timeless design. The interesting combination of tops with the modern easel base in steel lends to it a more linear and elegant style. Table tops in wood also available on bespoke sizes with longer delivery times.



piano in legno massello
solid wood top
827.28: 95x200 cm
827.29: 100x220 cm



piano in ceramica nera
black ceramic top
827.49: 100x220 cm



piano in vetro fumé "pluriball"
glass fumé "pluriball" top
827.69: 110x220 cm

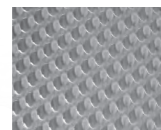

piano in ceramica nera con 2 allunghe in ceramica nera
black ceramic top with 2 extension in black ceramic
827.50: 100x200-300 cm



h 509
h 107.03
TT 827



H 908.84
TT 827





H 908.60
TT 827

U-TABLE 848/849

design **guggenbichler design**

Programma di tavoli con ampia scelta di piani con varie misure in diverse essenze di legno. Basi disponibili in acciaio lucido o laccato opaco.

Table program with wide range of table tops in different wood essences with various top dimensions. Table bases available in polished chrome and lacquered steel finishes.



Piano il legno massello

Solid wood top

849.09: 95x180 cm - 848.09 wild

849.19: 95x200 cm - 848.19 wild

849.29: 100x220 cm - 848.29 wild



Piano il legno massello - Angolo arrotondato.

Solid wood top - Round corner.

R49.09: 95x180 cm - R48.09 wild

R49.19: 95x200 cm - R48.19 wild

R49.29: 100x220 cm - R48.29 wild



Piano hpl per in&outdoor - Angolo arrotondato.

Hpl top for in&outdoor - Round corner.

849.80: 100x220 cm



h 904.93
TT 849

SALT&PEPPER 1 843

design **guggenbichler design**

Legno e metallo si combinano nelle diverse finiture, ottenendo un tavolo moderno e versatile.
The combinations of wood and metal are creating a modern and versatile table collection.



Piano in legno massello con lastra centrale in ceramica.
Solid wood top with central ceramic sheet
828.05: 100x220 cm



Piano in legno massello
Solid wood top
843.06: 95x180 cm
843.16: 95x200 cm
843.26: 100x220 cm



Piano in legno massello
Solid wood top
843.36: 100x220 cm



Piano in legno massello
Solid wood top
843.46: Ø 130 cm



Piano in legno massello - Angolo arrotondato
Solid wood top - Round corner.
R43.06: 95x180 cm
R43.16: 95x200 cm
R43.26: 100x220 cm





SALT&PEPPER 2 ECO 841

design **guggenbichler design**

Tavolo senza colla!
Table without glue!

Questo programma si completa con un piano in legno massello, realizzato unendo gli elementi che lo compongono con dei tiranti, senza alcun impiego della colla, proprio come fatto in un lontano passato da alcuni falegnami. La combinazione di questo piano prodotto senza utilizzo di colla e la sua finitura oleata consente a questo modello di essere riciclabile al 100% .
The Salt & Pepper table program expands with a solid wood top in oak and American walnut, the elements of the table top are held together with tie rods without using glue. The combination of this wooden top with an oiled finish, without the use of glue, the solid wood legs and the steel detail, make this model 100% recyclable.



Piano in legno massello
Solid wood top
841.27: 100x220 cm



SALT&PEPPER 2 - ECO



H 230.03
h 661.05
h 151.03
h 144.03
TT 841.27

TABULA-A 230

design **peter maly**

La grande "A".
The big "A".

Che cosa significa la lettera A nel nome del prodotto? Guardando il tavolo di fianco, si riconosce una forma che ricorda quella di una lettera: una grande A.

What does the A in the name mean? If you look at the table from the side, you can see a shape reminiscent of a letter – a large A.



piano in legno massello
solid wood top
230.95: 95x200 cm
230.97: 100x220 cm



piano in vetro grigio "no touch"
grey glass "no touch" top
230.92: 100x220 cm



piano in ceramica nera
black ceramic top
230.49: 100x220 cm



H 230.02
TT 230

TUBE 257

design **cuno frommherz**

Assimmetria & Armonia.
Asymmetry & Harmony.

Tube é un tavolo con base in tubolare d'acciaio caratterizzata da elementi inclinati sui quali poggia un piano rettangolare, disponibile in legno, vetroceramica o vetro.

Tube is a table with a tubular steel base characterized by inclined elements on which rests a rectangular top, available in wood, ceramic or glass.



piano in legno massello
solid wood top
257.28: 95x200 cm
257.29: 100x220 cm



piano in ceramica nera
black ceramic top
257.49: 100x220 cm



piano in vetro pluriball fumè
pluriball fumè glass top
257.69: 110x220 cm

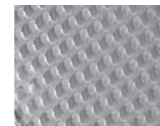

H 298.03
TT 257

ARCOS 277/ 277.24

design **pascal mourgue**

Un intricato gioco di geometrie.
An intricate game of geometries.

Un'interessante base, ottenuta dall'unione di molteplici elementi in metallo, diventa protagonista dell'arredo. I piani sono disponibili in diverse forme, con un'ampia scelta di materiali.

The base of the design, which has been created using various metal elements, becomes the main feature of the collection. The tops are available in different shape, with a wide choice of materials.



Piano in legno massello
Solid wood top
277.33: Ø 130 cm



Piano in HPL.
HPL top.
277.05: Ø 105 cm
Piano in laminato.
Laminated top.
277.10: Ø 110 cm



Piano in linoleum.
Linoleum top.
277.13: Ø 130 cm
277.15: Ø 150 cm

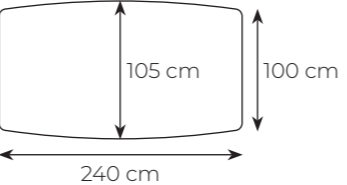

Piano in legno massello
Solid wood top.
277.24:



h 923.03
TT 277

MAC'S TABLE 216/217

design **mac stopa**

Un tavolo dalle mille possibilità.
A table with unlimited possibilities.

Base: soft touch - Piano: vetro

Base: Soft touch - Top: glass

213.04 = 4 elementi
213.04 = 4 elements

213.05 = 5 elementi
213.05 = 5 elements

213.04 x 2 = 8 elementi
213.04 x 2 = 8 elements
213.04 x 3 = 12 elementi
213.04 x 3 = 12 elements

213.08 = 8 elementi
213.08 = 8 elements

216.11: Ø 110 cm

216.13: Ø 130 cm
216.15: Ø 150 cm

217.58: 95x180 cm
217.62: 100x220 cm
217.30: 100x300 cm

217.63: 100x220 cm

Base: legno - Piano: vetro

Base: wood - Top: glass

213.14 = 4 elementi
213.14 = 4 elements

213.15 = 5 elementi
213.15 = 5 elements

213.14 x 2 = 8 elementi
213.14 x 2 = 8 elements
213.14 x 3 = 12 elementi
213.14 x 3 = 12 elements

213.18 = 8 elementi
213.18 = 8 elements

216.11: Ø 110 cm

216.13: Ø 130 cm
216.15: Ø 150 cm

217.58: 95x180 cm
217.62: 100x220 cm
217.30: 100x300 cm

217.63: 100x220 cm

Base: soft touch - Piano: legno

Base: Soft touch - Top: wood

213.05 = 5 elementi
213.05 = 5 elements



216.66: Ø 130 cm

Base: legno - Piano: legno

Base: wood - Top: wood

213.14 = 4 elementi
213.14 = 4 elements

213.15 = 5 elementi
213.15 = 5 elements



216.64: Ø 110 cm



216.66: Ø 130 cm

L'elemento base del table-system, prodotto nell' innovativo materiale medium soft-touch o nella versione in legno , é la chiave del suo successo. Con lo stesso elemento é possibile creare innumerevoli combinazioni. In questo modo non viene posto alcun limite alla lunghezza del tavolo. Il singolo elemento é fornibile in soft touch o in legno di noce canaletto o di rovere. Un elemento di giunzione in acciaio tiene assieme tutti gli elementi. Il table-system può essere fornito anche su misura con tempi e costi su richiesta.

The key of its success is the base element of the table-system, available in the innovative material medium soft touch or in wood. With the same element it's possible to create innumerable combinations. In this way there is no limit to the table length. The single element in soft touch is available in different colors and the wood element is available in American walnut and oak. A steel junction component joints together all the base elements. The table system is available also on bespoke dimensions with quotation and lead time on demand.



H 91711
TT 216-213



H 004.25
TT 216

COLONNA 839

Minimal.
Minimal.

Colonna è un tavolo facilmente inseribile in ogni ambiente.

I piani sono in legno massello oppure in linoleum grigio antracite, la base del tavolo è in acciaio laccato.

Colonna is a table that fits easily in every environment. The round tops are available in different sizes and materials and are manufactured in solid wood or in anthracite gray linoleum; the table's base is in lacquered steel.



Piano in legno massello
Solid wood top
839.33: Ø 130 cm



Piano in linoleum.
Linoleum top.
839.13: Ø 130 cm
839.15: Ø 150 cm



h 923.81
TT 839

TIME 232

design **guggenbichler design**

Forme circolari ed essenziali Circular and essential shape

Time è realizzato con una struttura in noce canaletto massello appoggiata su una piastra in acciaio inox. Il piano è a scelta in vetro temperato trasparente oppure in legno massello.

The base of Time is made of solid wood, on a stainless steel plate. The top is in transparent tempered glass or massiv wood.



Piano in legno massello
Solid wood top
232.33: Ø 130 cm; h: 74 cm



Piano in vetro "extra white"
"Extra white" glass top
232.61: Ø 140 cm; h: 74 cm



h 661.01
TT 232.61
TT 232.01+232.11

SELLA

design **peter maly**

Per il ristorante e l'albergo.
For restaurants and hotels.

I programma di sedute "Sella" si abbina a questo tavolo caratterizzato da un piano in legno, con un profilo accuratamente smussato e da una base in acciaio inox, sormontata da 4 elementi anch'essi in legno massello. "Sella" è un tavolo che grazie alle sue misure contenute è capace di conferire ottimi momenti di convivialità: un prodotto declinabile in contesti quali alberghi e ristoranti. Fornibile con piani in misure diverse.

The 'Sella' seating program matches with the Sella table, which is characterized by a wooden top, carefully beveled profile and a stainless-steel base. This is surmounted by four elements in solid wood. 'Sella' is a table that due to its small size, grants excellent moments of conviviality: a product that can be used in environments such as hotels and restaurants. Sella is available with table-tops in different sizes.



Piano in medium density impiallaciato con bordino in legno massello.

Top: veneered mdf with edges in solid beech

292.11: 60x60 cm; h: 73 cm

292.21: 90x90 cm; h: 73 cm



Piano in medium density impiallaciato con bordino in legno massello.

Top: veneered mdf with edges in solid beech

292.35: 60x60 cm; h: 105 cm



h 902.01
TT 292

LIBRA 298

design **matteo nunziati**

Armonia dei materiali.
Harmony of materials.

Sulla struttura in pregiato legno di noce massello poggia un piano in vetro, conferendo una sensazione di leggerezza.
On the structure in solid walnut wood rests a glass top, giving a feeling of lightness.



Piano in vetro fumè security.
Smoky grey security glass.
298.55: Ø 140 cm; h: 74,5 cm



Piano in vetro fumè security.
Smoky grey security glass.
298.65: Ø 140x140 cm; h: 74,5 cm



H 298.01
H 298.11
TT 298

GRACE 283

design **annette lang**

Graziosi tavolini da caffè.

Lovely coffee tables.

Linee organiche in armonia tra di loro che si intersecano, creano il design delle basi di questo tavolino, con giochi geometrici originali e accattivanti. I piani sono in Fenix, materiale ad alto contenuto tecnologico: la superficie risulta estremamente resistente ai graffi, incredibilmente opaca, anti impronta e morbida al tatto.

Organic lines which intersect in harmony with each other, help to create the base of this coffee table, with original and captivating geometric games. The tops are in Fenix, a material with a high technological content. The surface is extremely resistant to scratches, incredibly matt, anti-fingerprint and soft to the touch.



Piano in fenix
Fenix top
283.06: h= 32 cm

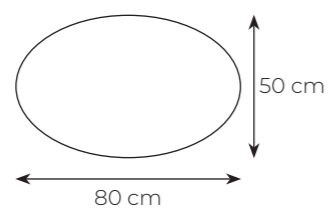

Piano in fenix
Fenix top
283.01: h= 50 cm

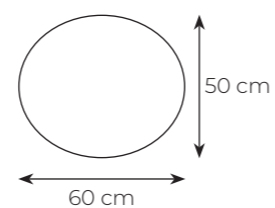

UP TABLE 917

design martin ballendat

Linee arrotondate e materiali di origine diversa.

Rounded lines and different kind of materials.

La particolare struttura centrale in noce canaletto massello sembra attraversare il piano in vetro trasparente, arricchito da un profilo in legno massello arrotondato. La base rotonda dà stabilità e carattere al prodotto e si abbina perfettamente ai dettagli in acciaio che sorreggono il piano.

The original central structure in solid American walnut seems to get through the top table in transparent glass which is enriched by a rounded edge in solid wood. The round base, available both in polished chrome steel and in the black lacquered version, gives stability and character to the product and perfectly matches the steel details that support the top.



Piano in vetro "extra white"
"Extra white" glass top
917.44/45: Ø 56 cm; h= 45-56 cm



H 917.28
TT 917.45

DIAMONDS 769

design **mathias demacker**

Forma esagonale.
Hexagonal shape.

Questi tavolini sono pensati per inserirsi nella sala d'attesa o in un salotto con grazia e raffinatezza. Il gusto intramontabile del legno si abbina al gioco di pieno e vuoto della struttura, che rende questo prodotto non solo un tavolino, ma anche un portariviste.

These coffee tables are designed to fit into a waiting room or living room with grace and refinement. The timeless taste of wood is combined with the playful nature of the structure, which makes this product not only a coffee table, but also a magazine rack.



769.01; h= 44 cm

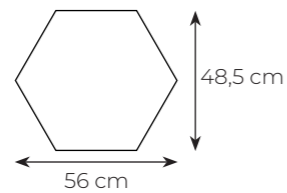

769.11; h= 40 cm

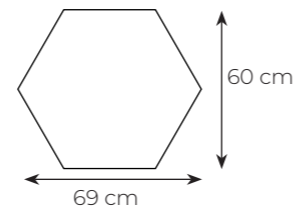

FRAME 851

design **mathias demacker**

Tre diverse altezze.
Three different heights.

Come suggerisce il nome, l'elemento caratterizzante del tavolino Frame è la struttura in metallo che "abbraccia" il piano. È sorretto a sua volta da un ulteriore elemento curvato in acciaio a forma di semicerchio ed è disponibile in finitura cromata, oppure laccato opaco. Il piano è disponibile in laminato, bianco o nero opaco.

As the name suggests, the characterizing element of the Frame coffee table is the metal frame that "embraces" the top. It is supported in turn by an additional curved steel element in the shape of a semicircle and it is available in either a chrome finish, or matt lacquered. The top is available in laminate, white or matt black.



Piano in laminato
Laminate top
851.40: Ø 60 cm; h= 40 cm



Piano in laminato
Laminate top
851.70: Ø 60 cm; h= 70 cm



Piano in laminato
Laminate top
851.98: Ø 60 cm; h= 98 cm



LIBRA COFFEE 298

design **matteo nunziati**

Disegno leggero e di grande finezza
Light design and great finesse.

La collezione Libra viene completata da questi tavolini eleganti. Sulla struttura in pregiato legno di noce massello poggia un piano in vetro, conferendo una sensazione di leggerezza.
The "Libra" collection is completed by elegant coffee tables. On the structure in fine solid walnut wood rests a glass top, giving a feeling of lightness.



Piano in vetro fumè
Smoky grey top
298.71: Ø 60 cm; h= 32 cm

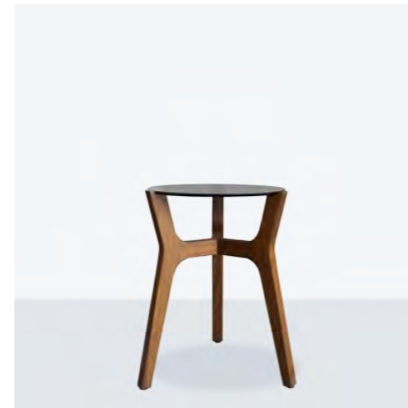

Piano in vetro fumè
Smoky grey top
298.81: Ø 35 cm; h= 49 cm



h 298.21
TT 298

TIME COFFEE 232

design **guggenbichler design**

Tavolini eleganti e senza tempo.
Elegant and timeless coffee tables.

Ogni tavolino Time è composto da una struttura in legno massello di noce canaletto o rovere su piastra in acciaio inox. Il piano è in vetro trasparente temperato. Lo troviamo in 3 diverse misure.

Each Time coffee table is composed of a solid walnut or oak wood frame on a stainless steel plate. The top is made of transparent tempered glass. We offer it in 3 different sizes.



Piano con vetro trasparente

Transparet glass top
232.21: Ø 125 cm; h= 40 cm

Piano con vetro pluriball

Pluriball glass top
232.22: Ø 125cm; h= 40 cm



Piano con vetro trasparente

Transparet glass top
232.11: Ø 70 cm; h= 41 cm

Piano con vetro pluriball

Pluriball glass top
232.12: Ø 70 cm; h= 41 cm



Piano con vetro trasparente

Transparet glass top
232.01: Ø 45 cm; h= 41 cm

Piano con vetro pluriball

Pluriball glass top
232.02: Ø 45 cm; h= 41 cm



PARENTESI 622

design **nicola bonriposi**

Uno scrittoio dalle dimensioni contenute, perfetto per l'home office.
Small desk, perfect for home office.

Disegnato da Nicola Bonriposi, Parentesi è uno scrittoio ideale come postazione per lavorare da casa. Due elementi verticali in lamellare di rovere curvati lo compongono ed ispirano il nome di questo prodotto, angolo accogliente e privato dove operare o studiare in tutta tranquillità.

Designed by Nicola Bonriposi, Parentesi is perfect for a home office. Two vertical elements in bent plywood inspire the name of this product, which appears as a welcoming and inviting spot to work or study in complete tranquility.



h 923.11
622 PARENTESI



h 907.61
622 PARENTESI

LAMPADA 531

design **guggenbichler design**

Elegante e senza tempo, proposta in tre altezze diverse.
Elegant and timeless, proposed in three different heights.

Tre elementi in legno di noce canaletto reggono un luminoso paralume, creando un'elegante simbiosi. Questa collezione di lampade senza tempo, in tre altezze diverse, risalta grazie alle sue proporzioni ed illumina con discrezione.

The bright lampshade is supported by an American walnut base, creating an elegant symbiosis. The collection of timeless lamps, in three different heights, stands out thanks to its proportions and illuminates a room with discretion.

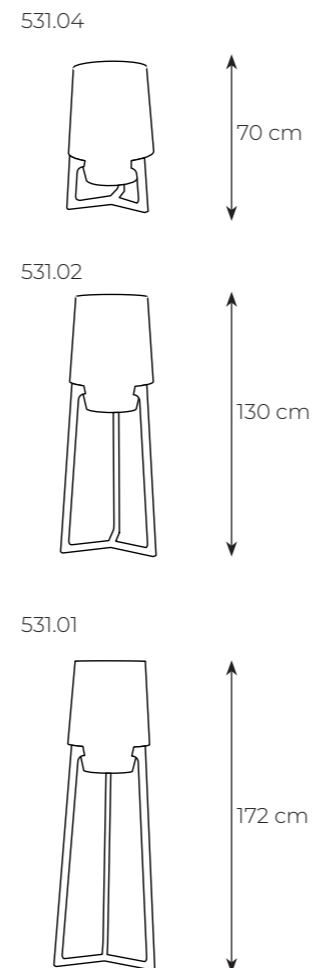

h 085.03
531.01 LAMPADA

Tonon spa si riserva il diritto di apportare quelle modifiche che ritenesse necessarie o migliorative ai propri prodotti. È vietata la riproduzione anche parziale di questo catalogo.

Tonon spa reserves the right to modify and improve its products when considered necessary without prior notice. It is strictly forbidden to copy and or reproduce this catalogue in full and or in part in any format.

Progetto Grafico / Graphic project:
Nicholas Macorig, Gaye Temizarabaci

Fotografie/Photos:
Silvio Salvador