

# Objects Oggetti.

Ascension, Cavalletto, Constellation, Dot Line,  
Fusilli, Gemma, Memory, Midi Basket, Multifunzione,  
O.J.C., Pic-nic, Puzzle, Rendez-vous, Stairs, Surf,  
Ted, Vis-à-vis, X

## Objects / Oggetti

Fun and functional ideas, surprising and convenient, capable of going beyond the usual conventions and expressing an advanced concept of bathroom design: all this is Agape, in both large and small solutions.

Idee divertenti e funzionali, sorprendenti e comode, capaci di andare oltre le solite convenzioni e di esprimere un concetto evoluto di stanza da bagno: tutto questo è Agape, nelle grandi come nelle piccole soluzioni.



## Ascension

Multifunctional seat / Seduta multifunzione

A handy accessory made of solid iroko wood with visible joints on the sides. A single object that, thanks to its versatility, offers two different functions depending on its position. Horizontally, it acts as a small step for the Immersion bathtub, while, if placed vertically, it doubles as a handy side table or storage area.

Comodo accessorio realizzato in massello di iroko con incastri a vista sui lati. Un solo oggetto che, grazie alla sua versatilità, regala due differenti funzioni a seconda della posizione. Posto in orizzontale, funge da scaletta per la vasca Immersion mentre in piedi si trasforma in un comodo tavolino o portaoggetti.

AVAS1983I

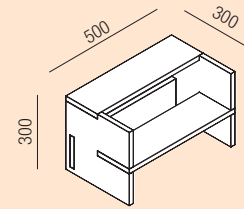

design Neri&Hu, 2018



## Ascension

Multifunctional seat / Seduta multifunzione



## Cavalletto

### Bench / Panca

Bench in birch plywood available in natural, brown or dark oak finish, which can be combined with the Agapecasa bookcases of the same name range. Cavalletto is available in two dimensions and a black leather cushion consisting of two symmetrical parts can be added to it.

Panca realizzata in multistrati di betulla con finitura rovere naturale, bruno o scuro abbinabile all'omonimo programma di librerie Agapecasa. Cavalletto è disponibile in due dimensioni ed è accessoriabile con cuscino in pelle nera composto da due parti simmetriche.

ACVL0391\_

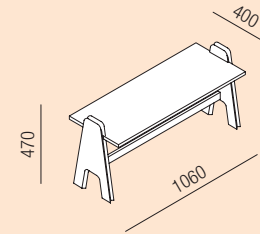

design Angelo Mangiarotti, 1953



## Cavalletto

### Bench / Panca



## Constellation

### Extras / Complementi

Programme for bathroom storage accessories consisting of mirrors and containers with or without lids. Made of white Carrara or black Marquina marble. The post-modern shapes of the collection emphasise the sculptural aspect of smooth marble as if sculpted by water. The lids and details are in natural brushed brass.

Programma di complementi da appoggio per il bagno composto da specchi e da contenitori con o senza coperchio. Realizzato in marmo bianco di Carrara o nero Marquina. Le geometrie post-moderne della collezione enfatizzano l'aspetto scultoreo del marmo levigato come se fosse plasmato dall'acqua. I coperchi e i dettagli che caratterizzano gli oggetti sono realizzati in ottone naturale spazzolato.

**ACOM0306\_**  
Tray / Vassoio

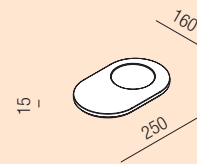

**ACOM0302\_**  
Objects container  
/ Contenitore porta oggetti

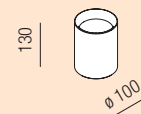

**ACOM0305\_**  
Objects container  
with lid / Conteni-  
tore porta oggetti  
con coperchio

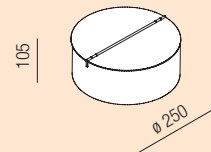

ACOM0306\_

ACOM0302\_

ACOM0305\_



design Studiopepe, 2018



## Constellation

### Tabletop mirrors / Specchi da tavolo

Tabletop horizontal or vertical mirror with base in white Carrara or black Marquina marble. The details are in natural brushed brass. They inject an eye-catching and functional look to any bathroom, when placed near the bathtub or on a container, but they are also perfect in other parts of the home, when gracing a desk or bookcase.

Specchi da tavolo orizzontali o verticali con base in marmo bianco di Carrara o nero Marquina. I dettagli che caratterizzano gli oggetti sono realizzati in ottone naturale spazzolato. Trovano la loro collocazione estetica e funzionale sia nel bagno – vicino alla vasca o su un contenitore – sia negli altri ambiti del paesaggio domestico, come su una scrivania o una libreria.

**ACOM0301\_**

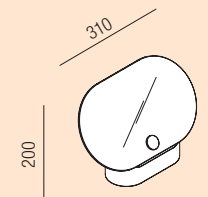

**ACOM0300\_**

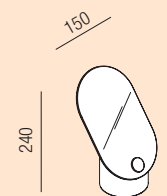

ACOM0301\_

ACOM0300\_



design Studiopepe, 2018



## Dot Line

### Towel holders / Porta salviette

Free standing towel holder elaborating on the minimal geometries of the Dot Line family. Mobile and adaptable, at easy next to the bathtub just as near a washbasin or a bidet, Dot Line is available with its structure in black brushed anodized aluminium or covered in three different wood essences. The base can be ordered in four different marbles for a great number of different combinations.

Porta salviette da terra che riprende il rigore delle geometrie minime della famiglia Dot Line. Versatile e mobile, a suo agio vicino alla vasca così come accanto al lavabo o al bidet, Dot Line è disponibile con la struttura in alluminio spazzolato nero o rivestito in tre diverse essenze di legno e la base in quattro finiture di marmo per un grande numero di possibili combinazioni.

ADTL0462\_

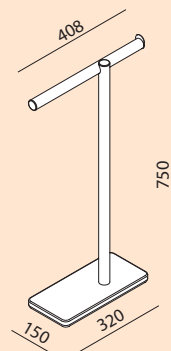

Line finish / Finitura barra



Base finish / Finitura base



design García Cumini, 2016



## Fusilli

### Mirrors / Specchi

The chrome-plated double flexible support allows Fusilli to be positioned at any angle. The mirror is double-sided, with one magnifying surface. Numerous installation options are available: on the wall, on a countertop, or freestanding, using a square white Carrara marble base, which adds a distinguished air.

Fusilli è orientabile in infinite direzioni grazie al doppio supporto flessibile cromato. Lo specchio è bifacciale con un lato ingranditore. Molteplici le possibilità di installazione: a parete, su piano, oppure in appoggio grazie alla base quadrata in marmo bianco di Carrara dalla presenza importante.

ASPE012P

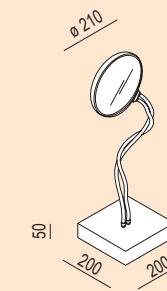

design Benedini Associati, 1997



## Gemma

### Extras / Complementi

Gemma is a program of bathroom complements consisting of containers with or without lid, trays and a small table. The trays/lids are made of stainless steel with satin or brushed burnished finish. The cylindrical containers in curved multi-layer birch plywood are clad with natural, brown or dark oak, or opaque lacquered white or grey and the interior is always covered with light gray melamine paper. The top of the small table is also available with opaque white lacquered edge.

Gemma è un programma di complementi per il bagno composto da contenitori con o senza coperchio, vassoi e tavolino. I vassoi/coperchi sono realizzati in acciaio inox con finitura satinata o brunito spazzolato. I contenitori cilindrici in multistrato di betulla curvato hanno rivestimento esterno in rovere naturale, bruno o scuro oppure sono laccati opachi in bianco o grigio, la parte interna è sempre rivestita con carta melaminica color grigio chiaro. Il piano per il tavolino è disponibile anche con fascia esterna laccata in bianco opaco.

design Sebastian Herkner, 2016



## Gemma

### Extras / Complementi

ACOM255\_

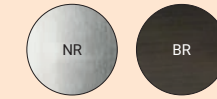
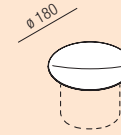

ACOM256\_

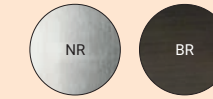
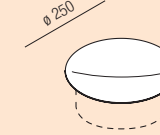

ACOM257\_

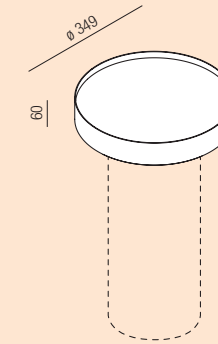

ACOM251\_

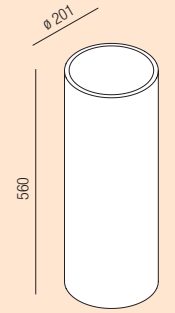

ACOM254\_

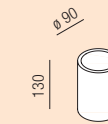

ACOM253RU

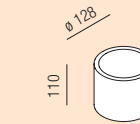

ACOM252RT

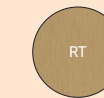
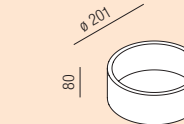

## Memory

### Towel holders / Porta salviette

Free-standing towel holder in stainless steel that inherits its delicate lines from the Memory Collection to which it belongs. Its ben calibrated geometries and timeless lines make it a very versatile object both functionally and aesthetically. The ideal complement to a freestanding bathtub or washbasin, Memory is available with chromed, brushed natural or burnished brass structure, while its base can be ordered in five different finishes between solid surface and marble.

Porta salviette da terra in acciaio inox che eredita le sue delicate linee dalla collezione Memory a cui appartiene. Le sue geometrie ben calibrate e le sue linee senza tempo lo rendono un oggetto poliedrico sia dal punto di vista funzionale che da quello estetico. Complemento ideale di una vasca freestanding o di un lavabo a colonna, il porta salviette Memory è disponibile con la struttura cromata, ottone spazzolato naturale o brunito, mentre la base è ordinabile in cinque differenti finiture tra solid surface e marmo.

AMEM862A\_

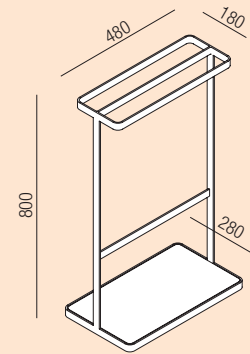

Structure finish  
/ Finitura struttura

Base finish  
/ Finitura base

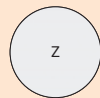
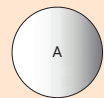

design Benedini Associati, 2010



## Midi Basket

### Containers / Contenitori

Roomy, cylindrical-shaped container made of curved plywood and available in a natural, brown or dark oak finish or in reconstituted wood, teak finish or in white or grey. Holes in the sides make it easy to move it. Midi Basket is a comfy waste paper for the bathroom.

Contenitore di forma cilindrica realizzato in multistrato curvato, disponibili con finitura in rovere naturale, bruno o scuro o in legno precomposto in finitura teak oppure nei colori bianco o grigio. Midi Basket è un comodo gettacarta per la stanza da bagno.

ACOM0601\_

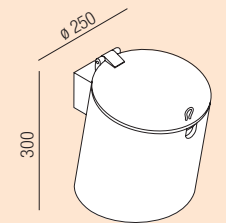

design Benedini Associati, 1996





## Multifunzione

### Side tables / Servomuto

Completely made from white Exmar, this is a useful towel holder and shelf, to be placed near a bathtub or washbasin.

Tutto realizzato in Exmar bianco, è un comodo accessorio portaoggetti e portasalviette, da affiancare alla vasca o al lavabo.

ACOM0509Z

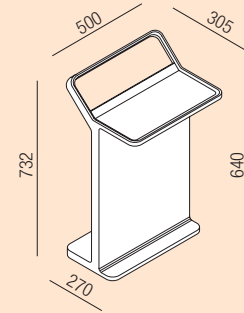

design Benedini Associati, 2009



## O.J.C.

### Storage unit / Contenitore

Warmth and dynamism are the characteristic features of O.J.C., the storage trolley unit in natural, brown or dark oak or reconstituted wood, teak finish, or in white or grey lacquer, divided into three sections, accessible from the top with swivel opening and a chromed brass handle.

Calore e dinamismo caratterizzano O.J.C., il contenitore su ruote in rovere naturale, bruno, scuro, legno precomposto con finitura teak o laccato in bianco o grigio, diviso in tre settori fruibili dall'alto con apertura a rotazione e una maniglia in ottone cromato.

ACOM0500N\_

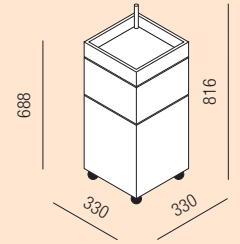

design Benedini Associati, 1991 / 2014

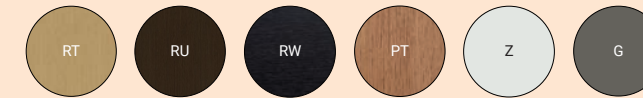

**Pic-nic**

## Towel holders / Porta salviette

Floor standing towel holder in natural, brown, dark oak or painted teak or painted white or grey with embossed finish, with natural leather band, available in two different widths: 63 cm or 49 cm.

Portasalviette da terra in rovere naturale, bruno, scuro, tinto teak o verniciato in bianco o grigio, con fascia in cuoio naturale, disponibile in due larghezze cm 63 o cm 49.

ACOM0530\_

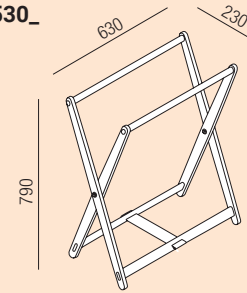

ACOM0530\_S

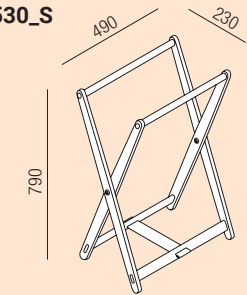

ACOM0530\_



ACOM0530\_S



design Benedini Associati, 1993

**Pic-nic**

## Towel holders / Porta salviette



## Puzzle

### Extras / Complementi

Countertop or drawer accessories to use in the containers of the Agape programmes. Made of massive ash wood, grey painted with open-pore finish. The different boxes can be positioned individually or inserted in the respective tray in various positions.

Accessori da appoggio o per cassetti da inserire nei contenitori dei programmi Agape. Realizzati in massello di frassino con verniciatura laccata grigia a poro aperto. I vari box possono essere posizionati singolarmente o inseriti nel vassoio in più posizioni.

ALEG521GR

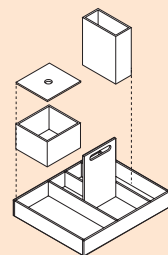

ALEG522GR

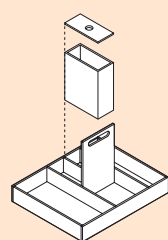

ALEG521GR

ALEG522GR

GR

GR

design Benedini Associati, 2011



## Rendez-vous

### Bench / Panca

Two benches with two heights whose table top is formed from cork ropes, with a technical core in metal, woven by hand. In addition to the benches, the range also includes a daybed complemented by a mattress and cushion made of hemp fabric. The supports and frame are made of aluminum tubing painted in a warm brick red (RAL2001) or dark brown (RAL8019).

Due panche con due altezze il cui piano d'appoggio prende forma da corde di sughero, con un'anima tecnica in metallo, intrecciate a mano. Oltre alle panche, la gamma comprende anche un daybed integrato da materasso e cuscino in tessuto di canapa. I sostegni e la struttura sono in tubolare di alluminio verniciato in una calda tonalità rosso mattone (RAL2001) o in marrone scuro (RAL8019).

ARDV1804236SU\_

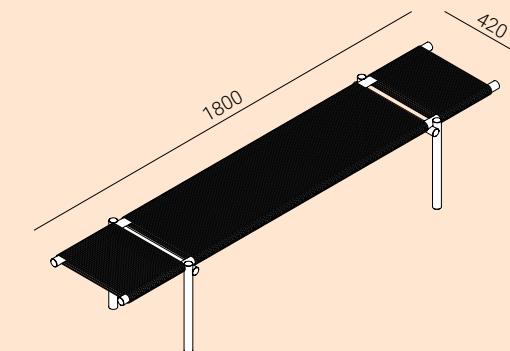

AR

MG

design Marco Carini, 2022

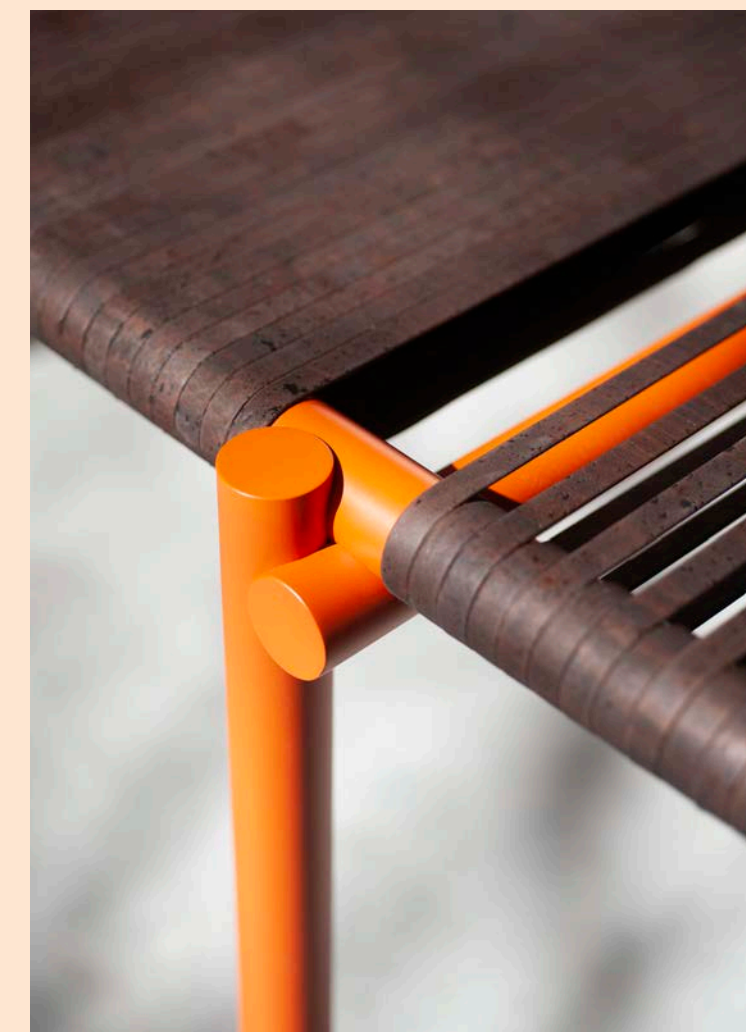

## Stairs

## Extras / Complementi

Towel rail or bookshelf white five shelves in natural or dark oak or white painted finish, floor standing and resting against the wall.

Elemento porta salviette o elemento con cinque ripiani in rovere naturale, scuro o verniciato in bianco, in appoggio a terra e alla parete.

ACOM0531N\_

ACOM0534N\_

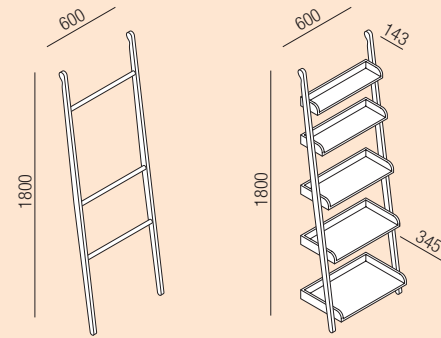

ACOM0531N\_

ACOM0534N\_

501

501



1.369

1.369



design Benedini Associati, 1996



## Surf

## Extras / Complementi

White Cristalplant® countertop accessories for the washbasin area. They can also be placed on the Surf trays, made in the same material or in marble.

Elementi d'appoggio per la zona lavabo realizzati in Cristalplant® bianco. Possono essere collocati anche sui vassoi porta oggetti Surf realizzati nello stesso materiale o in marmo.

ACOM0626\_

ACOM0627\_

ACOM065Z

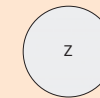
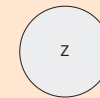
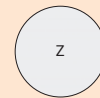
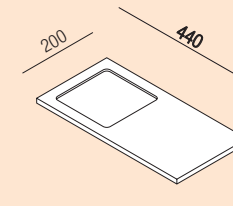
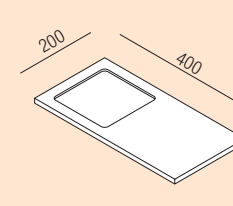
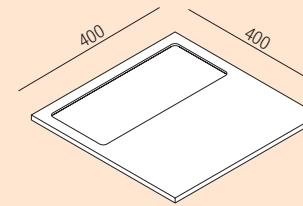

design Benedini Associati, 2007



## Ted

### Side tables / Servomuto

A practical tool for the organization of the bathroom, always at hand. Freestanding and adjustable in height, with shelf, towel rack and toilet roll holder in polished stainless steel with basis and shelf in white solid surface, to complement washbasins, bathtub or sanitary ware.

Un pratico strumento per l'organizzazione dell'ambiente bagno sempre a portata di mano. Accessorio da terra regolabile in altezza con porta oggetti, portasalviette e porta rotolo in acciaio inox lucido con base e ripiano in solid surface bianco, da affiancare a mobili, lavabo, vasca o sanitari.

ACOM0514Z

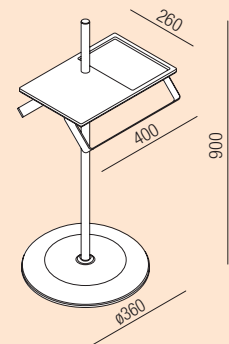

design Daniele Dalla Pellegrina, 2013



## Vis-à-vis

### Seat / Seduta

Vis-à-vis is a light and maneuverable stool made entirely of natural or heat-treated cork.

It can also be used as a small side table. Removing a slice from the cylindrical body creates a curve that has the same radius as the base. That means one piece can be linked to another indefinitely, even creating a circular motion. That same curve also allows two people to sit comfortably facing each other on two stools.

Like Rendez-vous, the Vis-à-vis stool too has been designed to be water-resistant for an extremely wide range of uses.

Vis-à-vis è uno sgabello leggero e maneggevole, interamente in sughero naturale o tostato.

Un elemento utilizzabile a piacere anche come tavolino da appoggio. Eliminando uno spicchio dal corpo a cilindro si crea una curva che ha lo stesso raggio della base. In questo modo si può accostare ogni elemento all'altro all'infinito e comporre, se lo si desidera, anche un movimento circolare. La stessa curva permette a due persone di sedersi su due sgabelli e stare comodamente l'una di fronte all'altra.

Come Rendez-vous, anche lo sgabello Vis-à-vis è pensato per funzionare a contatto con l'acqua per una gamma di utilizzi estremamente ampia.

ACOM0544\_

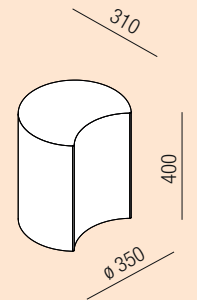

design Marco Carini, 2022



X

## Extras / Complementi

A handy, versatile wooden accessory in natural, brown, dark oak or painted teal or grey. The structure can be accessorised with a tray to create a handy table or portable storage shelf. Without the tray, the tall structure becomes a handy towel rack.

Un comodo accessorio realizzato in rovere naturale, bruno, scuro, tinto teak o verniciato in bianco o grigio. La struttura può essere accessoriata con il vassoio, utilizzabile come tavolino o portaoggetti. Senza vassoio la struttura alta è un pratico porta salviette.

design Benedini Associati, 2012

AMET1877\_

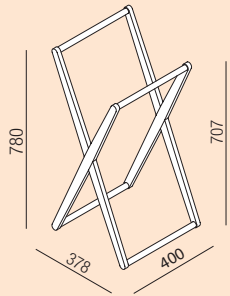

ACOM0622\_

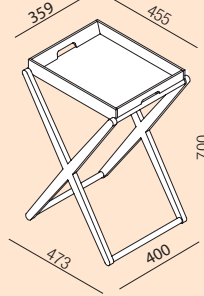

ACOM0623\_

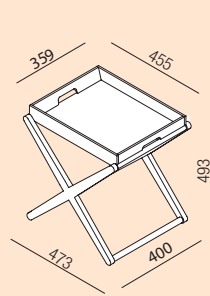

X

## Extras / Complementi



©Agape srl 10.2024

**Agape srl reserves the right to make changes to the products in the catalogue at any time and without notice, should they be deemed necessary for production, aesthetic or technical purposes. The products in this catalogue can be supplied with other finishes that can be found in the pricelist.** / Agape srl si riserva la facoltà di apportare modifiche ai prodotti a catalogo senza preavviso, qualora si rendessero necessari per esigenze produttive, estetiche o tecniche. I prodotti inseriti in questo catalogo possono essere forniti con altre finiture consultabili a listino.

Agape srl  
via A. Pitentino, 6 / 46037  
Governolo Roncoferraro (MN), Italy  
T +39 0376 250311  
[www.agapedesign.it](http://www.agapedesign.it)  
☒ @agapebathrooms  
☒ @agapedestinations  
☒ @agapebosco